

 **GES** / *Spécialiste mondial de l'événement*
Clarkson-Conway

**BONS DE COMMANDE
SERVICES D'EXPOSITIONS**

CANADIAN NEUROSCIENCE MEETING 2014

EXHIBITOR SERVICES & FORMS

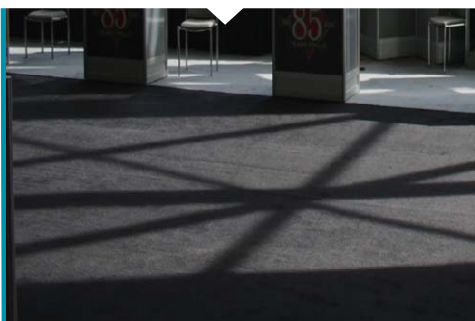



ORDER FORMS

Dear Exhibitor,

We are pleased that **GES Global Experience Specialists** has been selected as your Official Service Contractor for:
CANADIAN NEUROSCIENCE MEETING 2014

We strive to offer you the best possible service to facilitate a successful show experience. Please review this manual carefully. It contains information and order forms for each of the many services offered by GES Global Experience Specialists. In order to provide efficient service for you it is most important that you return these forms to us promptly.

By placing your orders in advance, you can **save 40%** on most decorating items. Advance orders also make for a smoother, more efficient move-in avoiding unnecessary waits, the possibility of selecting a sold out item and showsite delivery delays.

To qualify for discount prices, orders must be received in our office on or before the deadline date on the order forms. Please be sure to reference each order form as deadline dates may vary. GES Global Experience Specialists requires payment in full at the time services are ordered. For your convenience, we require that you provide a credit card authorization with your initial order. This may be used to charge labour and material handling services not covered in your advance order. We accept Visa, Mastercard, American Express, as well as cheques.

We realize that exhibiting in a tradeshow can be complicated. If you need assistance with your orders or additional information, please call our offices at **514-861-9694 from Monday to Friday from 8:30am until 4:30pm** and ask to speak to a Customer Service Representative (CSR). In addition, our GES Global Experience Specialists Servicecentre staff will be available throughout the show to assist you.

Thank you in advance for your valued business. We look forward to serving you and wish you a successful event.

INTERNET:

Ordering online. To access our online forms, go to www.gesexpo.ca.

Enter the city and click on "online ordering"

Sincerely,
Customer Service Team

GES Global Experience Specialists
Clarkson-Conway
800, rue de la Gauchetière Ouest, suite 1165
Montréal, Québec H5A 1K6
Phone: 514-861-9694 Fax: 514-392-1577
Email: clarkson@ges.com

CANADIAN NEUROSCIENCE MEETING 2014
MAY 26-28, 2014
HILTON MONTREAL BONAVENTURE, FONTAINE A-H

BOOTH EQUIPMENT (Each Exhibit space includes)

This package includes:

8' high background and 3' high side dividers in blue drape

One 6'Lx30"Hx24" table with blue skirt

Two grey side chairs

ELECTRICITY

For all electrical needs please consult the enclosed Electricity order form and return it directly to the hotel.

EXHIBIT HALL CARPET

The exhibit hall is carpeted.

DISCOUNT PRICE DEADLINE DATE

In order to receive advance order discount rates listed on the price sheet, we must receive your order and payment by:

May 9th, 2014

SHOW SCHEDULE

EXHIBITOR MOVE-IN

Sunday, May 25th, 2014 • 12 pm - 5 pm

GES SERVICE DESK

Sunday, May 25th, 2014 • 12 pm - 5 pm

EXHIBIT HOURS

Monday, May 26th, 2014

Poster/expo • 9:45 am - 11 am / 2:30 pm - 5 pm

Lunch • 12 pm - 1 pm

Tuesday, May 27th, 2014 • 8 am - 5 pm

Poster/expo • 9:45 am - 11 am / 2:30 pm - 5 pm

Lunch • 12 pm - 1 pm

Wednesday, May 28th, 2014 • 8 am - 5 pm

Poster/expo • 9:45 am - 11 am / 1 pm - 3 pm

EXHIBITOR MOVE-OUT

Wednesday, May 28th, 2014 • 3 pm - 5 pm

SHIPPING INFORMATION

Please review this section of the Exhibitor Kit thoroughly for: the proper shipping address to the facility, all information relating to advance freight, storage, and materials handling of your goods during the move-in and move-out process.

OFFICIAL DECORATOR AND TRANSPORT (DOMESTIC) COMPANY OFFICIAL CARRIER (INTL.) & CUSTOMS BROKER

GES CANADA / Clarkson-Conway
800 Place Bonaventure, Suite 1165
Montréal, Québec

Mendelssohn Event Logistics
276 St. Jacques Street West, Suite 818
Montreal, QC H2Y 2G4

PAYMENT & CREDIT CARD CHARGE AUTHORIZATION

CANADIAN NEUROSCIENCE MEETING 2014
MAY 26-28, 2014
HILTON MONTREAL BONAVENTURE, FONTAINE A-H

COMPANY NAME			NAME	
STREET		PHONE	FAX	EMAIL
CITY	PROVINCE/STATE	POSTAL CODE	SHOW SITE CONTACT AND PHONE NUMBER	

Payment for Services - Global Experience Specialists requires payment in full at the time services are ordered. Further, GES Global Experience Specialists requires that you provide a credit card authorization with your initial order. For your convenience, we will use this authorization to charge your account for services, which may include labour and material handling, not covered by your initial payment. All applicable taxes will be added and charged to your credit card.

Discount Pricing - To qualify for discount pricing, orders must be received with payment on or before the discount price deadline.

Method of Payment - Global Experience Specialists accepts American Express, Mastercard, Visa, cheque and wire transfers. Purchase orders are not considered payment. Exhibitors will be charged a 35.00 fee for NSF cheques or wire transfers (to cover the bank fees).

Third Party Billing - Each exhibiting firm is ultimately responsible for all charges incurred on it's behalf. Global Experience Specialists reserves the right to institute collection action against the exhibitor if the authorized third party does not pay.

Tax Exempt - If you are tax exempted in Canada you must provide a GST and/or QST Exemption Certificate. Please send the above information to the GES office for this show. Taxes vary by location and will be added to your invoice if you do not submit your tax exemption certificate prior to the deadline.

Adjustments & Cancellations - It is the responsibility of the exhibitor to advise GES Global Experience Specialists on-site representative(s) of any problem(s) with any of their orders. No adjustments will be made to invoices after the close of the show. All orders cancelled by the Exhibitor or due to the cancellation of an event or their non-participation may be subject to cancellation fees equal to 50% - 100% of the total order based upon the status of move-in, work performed, and/or Global Experience Specialists set up costs or expenses. Please refer to the individual forms for cancellation fees. A minimum non-refundable deposit of \$25.00 will be applied toward the invoice unless there is a cancellation of your order.

If you have any questions regarding our payment policy please call Global Experience Specialists at 514-861-9694 or visit the Global Experience Specialists Servicentre at the show.

Please complete the information and return payment in full with this form and your orders. You may choose to pay by credit card, cheque or wire transfer, however, we require your credit card charge authorization to be on file with Global Experience Specialists.

You agree to late fees of up to 1.5% per month on any balance not paid at the conclusion of the event or balance left without appropriate credit card on file.

For your convenience, we will use this authorization to charge your credit card for any additional amounts ordered by your representative or services rendered to your company for this event.

I agree in placing this order that I have accepted GES Global Experience Specialists payment Policy and Terms & Conditions of Contract



AUTHORIZED SIGNATURE

AUTHORIZED NAME - PLEASE PRINT

Credit Card Charge Authorization (All Information Must Be Provided)

Credit card number	Expiry date
	Security
<input type="checkbox"/> VISA <input type="checkbox"/> MC <input type="checkbox"/> AMEX	

Cardholder's Name

--

Cardholder Signature

--

FULL PAYMENT DUE

\$

To simplify payment, send a cheque payable to GES / Clarkson-Conway

Enclosed is a cheque in the amount of:

\$

COMPANY

BOOTH

Please send your order by:
Fax: 514-392-1577 or E-mail: clarkson@ges.com

Material Handling is the unloading of your exhibit materials, delivery to your booth, handling of empty containers to and from storage, and removal of your materials from your booth for reloading onto your outbound carrier. This is not to be confused with the cost to transport your exhibit material to and from the event.

Benefits of Advance Shipping to the GES Global Experience Specialists Warehouse

- Storage of materials for up to 30 days prior to your show.
- Delivery of shipments to your booth on your first day of move-in (schedule permitting).
- Some convention centres and hotels do not have facilities for receiving or storing freight.
- Saves valuable set-up time.

How to ship in Advance to the GES Global Experience Specialists Warehouse

- Remove all old shipping and empty storage labels.
- Fill out and attach enclosed Advance Shipping Labels.
- Complete the enclosed Advance Material Handling order form.
- All shipments must have a bill of lading or delivery slip showing the number of pieces, weight, and type of merchandise.
- Take the time to ensure that your display and products are packed neatly and securely.
- Do not ship uncrated materials to the warehouse.
- Please note that when utilizing a ground carrier other than the official, U.S. shipments will require customs clearance before delivery to the advance warehouse. Clearance delays may occur.

How to Ship to Exhibit Site

- Consign all shipments c/o GES Global Experience Specialists.
- Remove all old shipping and empty storage labels.
- Fill out and attach enclosed Direct Shipping labels.
- All shipments must have a bill of lading or delivery slip showing the number of pieces, weight, and type of merchandise.
- Take the time to ensure that your display and products are packed neatly and securely.
- If you are shipping your carpet and/or lighting trusses, make sure it is loaded last so it can be unloaded first.

Freight Carriers

Select a carrier with experience in handling exhibition materials. Make sure to give your carrier explicit information as to where and when to check-in. Delivery and pick up times are often out of the range of "normal" delivery hours, make sure your carrier is committed to meeting your target dates and times. While making shipping plans to the show, also plan for the return shipment.

Tracking Shipments

Confirm your delivery date and time with your carrier, and have all pertinent shipping information in the hands of your representative at showsite. You may also want to review the return of your goods at the end of the show.

Estimating Material Handling Charges

Handling charges are based on the weight of the freight. Shipments are billed by the hundredweight and rounded up to the nearest hundred. A minimum per shipment may apply, see enclosed Material Handling Order Form for details. Please prepay all shipping charges - GES Global Experience Specialists cannot accept or be responsible for collect shipments. Crated and uncrated shipments must be separated and clearly identified on your bill of lading.

- **Crated** - Material that is skidded or is any type of shipping container that can be unloaded at the dock with no additional handling required.
- **Uncrated** - Material that is shipped loose or pad-wrapped and/or unskidded machinery without proper lifting bars or hooks.
- **Special Handling** - Defined as shipments that are loaded by cubic space and/or packed in such a manner as to require special handling, such as ground loading, side door loading, constricted space loading, and designated piece loading or stacked shipments. Also included are mixed shipments and shipments without proper delivery receipts.

● **Overtime Surcharges** - Shows that move-in or move-out on weekends or late in the day may be subject to overtime surcharges. See enclosed Material Handling Order Form for details.

● **Late Surcharges** - A surcharge may apply if advance freight is received after the published deadline date for shipments to arrive at the warehouse. See enclosed Material Handling Order Form for details.

Storing Empty Containers

Properly labeled empty shipping cartons will be picked up, stored and returned after the show. Labels are available at the **GES Global Experience Specialists Servicentre** of from your GES Global Experience Specialists Service Representative and are for empty storage only. Depending on the size of the show, it can take from one (1) to four (4) hours to return empty crates. Do not store any items in crates marked empty.

Forced Freight

Shipments left on-site after dismantle hours will be transferred to a storage warehouse. Charges relating to such shipping and handling will be charged to the exhibitor.

Outgoing Shipments

An OMHF (Outbound Material Handling Form / Bill of Lading) must accompany all outgoing shipments. Shipping information, outbound forms and labels will be available at the **GES Global Experience Specialists Servicentre**. Exhibitors selecting non-official carriers will need to make their own arrangements for pickup. Make sure that someone from your company will be on-site to oversee the outbound shipment of your display and product.

Machinery, Labour and Equipment

Labour and equipment for uncrating, unskidding, positioning, leveling, dismantling, recrating, and reskidding machinery and/or equipment must be ordered separately. Place your order for this using the In-Booth Forklift and Labour Order Form. If your material requires specialized rigging equipment, please notify us promptly so that we can make arrangements. When possible supply your own rigging equipment with shipments and pre-rig your material.

Insurance

All of your goods should be insured by your own insurance policy. Although we do our best to handle your goods as our own, there are many variables in shipping and handling that can affect your exhibit and products. GES Global Experience Specialists has published GES Global Experience Specialists Terms & Conditions of Contract that are in your exhibitor service manual. Please read them carefully. It is recommended that your goods be insured.

GES Limits of Liability

● **Liability** - GES Global Experience Specialists is liable for loss or damage to your goods ONLY if the loss or damage was caused by GES Global Experience Specialists negligence.

● **Measure of Damage** - If GES Global Experience Specialists was negligent and the negligence caused either loss or damage to your goods, then the measure of that damage will be determined by the following:

a. Measure of Damages in all situations (including b. below) will be limited by the Depreciated Value of the goods or repair costs, whichever is less.

b. The lesser of \$0.30 per pound per piece, \$50 per piece, or \$1000 per occurrence.

GES Global Experience Specialists does not offer or sell insurance. GES Global Experience Specialists is not liable and will not owe for loss or damage to your goods if the damage was not caused by GES Global Experience Specialists.

CANADIAN NEUROSCIENCE MEETING 2014

MAY 26-28, 2014

HILTON MONTREAL BONAVENTURE, FONTAINE A-H

A/S (C/O) Démark

9235, rue Boivin

Lasalle, Qc

H8R 2E8

Ce service inclut le déchargement à l'entrepôt et la livraison à votre kiosque au:

The rate for this service includes unloading at the warehouse and delivery to:

Hilton Montreal Bonaventure

Envois arrivant entre **7 au 21 mai 2014**

Shipment arriving between: **May 7-21, 2014**

Ce service n'inclut pas le retour à l'entrepôt à la fin de l'exposition. Votre transporteur doit ramasser votre matériel au débarcadère du lieu de l'exposition avant la fin du démontage sinon des frais d'entreposage vous seront chargés.

This service does not include returning the shipments to the warehouse at the end of the show. Your transporter must pick-up your shipment(s) at the loading dock of the venue before the end of the move-out or you will be charged for storage or for transport fees.

IDENTIFIEZ ET ADRESSEZ TOUT VOTRE MATÉRIEL "TOUS FRAIS PRÉPAYÉS" / MARK AND CONSIGN SHIPMENTS "BILL ALL CHARGES TO SHIPPER"

Veuillez vous référer aux étiquettes d'expédition de ce manuel. / Please refer to the shipping labels in this manual.

GES Spécialiste mondial de l'événement n'assumera aucune responsabilité pour la marchandise non emballée, mal emballée ou avec des dommages déjà apparents, la perte, le vol ou la disparition de toute marchandise après qu'elle soit livrée au kiosque de l'exposant ni avant la cueillette au kiosque de l'exposant pour le chargement après l'exposition. / GES Global Experience Specialists shall not be responsible for damage to uncrated materials, improperly packed materials, concealed damage, loss or theft of exhibitor materials after being delivered to booth during installation; nor before being picked up for shipping out from the building.

Si vos transporteurs désignés ne ramassent ou ne livrent vos matériaux à temps, ni le promoteur ni GES Spécialiste mondial de l'événement ne sera responsable des délais subséquents. / If your designated carriers do not pick up or make destination delivery of your shipment on time, neither show management nor contractor will be liable for any resulting delays.

MÉTHODE DE CALCUL DES FRAIS / METHOD OF CALCULATION OF CHARGES

Il est entendu que votre calcul est un estimé. La facturation sera faite à partir du poids réel. Les ajustements seront effectués en conséquence. / We understand that your calculation is only an estimate. Invoicing will be done from the actual weight. Adjustments will be made accordingly.

Notre envoi sera envoyé à l'entrepôt le / Our shipment will be sent to the warehouse on:	
Nombre de morceaux / Total Pieces:	
Dimensions de la plus grosse unité / Size of largest piece:	
Poids de la plus grosse unité / Weight of largest piece:	
78,50\$/100 lbs. ≥ 50 lbs. 200 lbs (157,00\$ Minimum charge)	x 78,50\$
52,00\$ ≤ 50 lbs. Envoi / Shipment	x 52,00\$
99,50 \$ /100 lbs. Manutention spéciale/ Special handling (Minimum charge 199,00\$)	x 99,50\$
<p>Vous devez OBLIGATOIREMENT joindre le formulaire d'autorisation de carte de crédit à ce formulaire / The payment & credit card authorization form MUST accompany this form.</p> <p>Toutes les commandes sont soumises aux politiques de paiement et aux limites de responsabilités de GES Spécialiste mondial de l'événement stipulées dans ce manuel de l'exposant. / All orders are governed by the GES Global Experience Specialists Payment Policy and Limits of Liability & Responsibility as specified in this Exhibitor Kit.</p> <p>INDEMNITÉ D'ANNULATION: Après le début du montage de salon, toute annulation sera facturée à 50% du coût original et à 100% après la livraison.</p> <p>CANCELLATION CLAUSE: Items cancelled after move-in begins will be charged at 50% of the original price and 100% after installation.</p>	Montant / Amount:
	R100992197 - TPS 5% GST
	1000169915 - TVQ 9.975% QST
	TOTAL
	COMPAGNIE - # STAND
	COMPANY - BOOTH #
<p>Faite parvenir votre commande par / Please send your order by:</p> <p>Télécopieur / Fax: 514-392-1577 ou Courriel / Email: clarkson@ges.com</p>	

UTILISEZ CES ÉTIQUETTES D'EXPÉDITION CAR ELLES VONT FACILITER LA MANUTENTION. Des copies de ces étiquettes sont acceptées si une quantité plus grande est nécessaire.
USE THESE SHIPPING LABELS AS THEY WILL EXPEDITE HANDLING. Copies of these labels are acceptable if additional labels are needed.

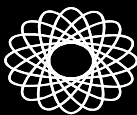

GES / *Spécialiste mondial de l'événement*

Clarkson-Conway

MATÉRIAUX D'EXPOSITION

EXPÉDITION À L'AVANCE

À:

NOM DE LA COMPAGNIE

CANADIAN NEUROSCIENCE MEETING 2014

NOM DE L'EXPOSITION

NUMÉRO DE STAND

A/S (C/O)

Démark

9235, rue Boivin

Lasalle, Qc

H8R 2E8

**HEURES D'OUVERTURE DE L'ENTREPÔT:
LUNDI AU VENDREDI 10:00 À 16:00**

Transporteur

Nombre _____ de _____ morceaux

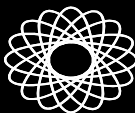

GES / *Spécialiste mondial de l'événement*

Clarkson-Conway

EXHIBITION FREIGHT

ADVANCE SHIPMENT

TO:

COMPANY NAME

CANADIAN NEUROSCIENCE MEETING 2014

NAME OF EXHIBITION

BOOTH NUMBER

A/S (C/O)

Démark

9235, rue Boivin

Lasalle, Qc

H8R 2E8

**WAREHOUSE HOURS ARE
MONDAY TO FRIDAY 10:00 AM TO 4:00 PM**

Carrier

Number _____ of _____ pieces

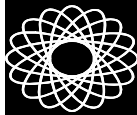

GES / *Spécialiste mondial de l'événement*

Clarkson-Conway

MATÉRIAUX D'EXPOSITION

EXPÉDITION À L'AVANCE

À:

NOM DE LA COMPAGNIE

CANADIAN NEUROSCIENCE MEETING 2014

NOM DE L'EXPOSITION

NUMÉRO DE STAND

A/S (C/O)

Démark

9235, rue Boivin

Lasalle, Qc

H8R 2E8

**HEURES D'OUVERTURE DE L'ENTREPÔT:
LUNDI AU VENDREDI 10:00 À 16:00**

Transporteur

Nombre _____ de _____ morceaux



GES / *Spécialiste mondial de l'événement*

Clarkson-Conway

EXHIBITION FREIGHT

ADVANCE SHIPMENT

TO:

COMPANY NAME

CANADIAN NEUROSCIENCE MEETING 2014

NAME OF EXHIBITION

BOOTH NUMBER

A/S (C/O)

Démark

9235, rue Boivin

Lasalle, Qc

H8R 2E8

**WAREHOUSE HOURS ARE
MONDAY TO FRIDAY 10:00 AM TO 4:00 PM**

Carrier

Number _____ of _____ pieces

CANADIAN NEUROSCIENCE MEETING 2014

MAY 26-28, 2014

HILTON MONTREAL BONAVENTURE, FONTAINE A-H

A/S (C/O) Débarcadère du Place Bonaventure Loading Dock

Coin St-Jacques & Montfort / Corner St-Jacques & Montfort

Montréal, QC, H5A 1G1

Aucune marchandise ne peut être accepté avant: Sunday, May 25th, 2014 • 12 pm - 5 pm
No shipment will be accepted before :

Ce service n'inclut pas le retour à l'entrepôt à la fin de l'exposition. Votre transporteur doit ramasser votre matériel au débarcadère du lieu de l'exposition avant la fin du démontage sinon des frais d'entreposage vous seront chargés.

This service does not include returning the shipments to the warehouse at the end of the show. Your transporter must pick-up your shipment(s) at the loading dock of the venue before the end of the move-out or you will be charged for storage or for transport fees.

IDENTIFIEZ ET ADRESSEZ TOUT VOTRE MATÉRIEL "TOUS FRAIS PRÉPAYÉS" / MARK AND CONSIGN SHIPMENTS "BILL ALL CHARGES TO SHIPPER"

Veuillez vous référer aux étiquettes d'expédition de ce manuel. / Please refer to the shipping labels in this manual.

GES Spécialiste mondial de l'événement n'assumera aucune responsabilité pour la marchandise non emballée, mal emballée ou avec des dommages déjà apparents, la perte, le vol ou la disparition de toute marchandise après qu'elle soit livrée au kiosque de l'exposant ni avant la cueillette au kiosque de l'exposant pour le chargement après l'exposition. Toute réclamation doit être faite sur les lieux avant la fermeture de l'événement. / GES Global Experience Specialists shall not be responsible for damage to uncrated materials, improperly packed materials, concealed damage, loss or theft of exhibitor materials after being delivered to booth during installation; nor before being picked up for shipping out from the building. Claims must be filed by the exhibitor before close of show.

Si vos transporteurs désignés ne ramassent ou ne livrent vos matériaux à temps, ni le promoteur ni GES Spécialiste mondial de l'événement ne sera responsable des délais subséquents. / If your designated carriers do not pick up or make destination delivery of your shipment on time, neither show management nor contractor will be liable for any resulting delays.

MÉTHODE DE CALCUL DES FRAIS / METHOD OF CALCULATION OF CHARGES

Il est entendu que votre calcul est un estimé. La facturation sera faite à partir du poids réel. Les ajustements seront effectués en conséquence. / We understand that your calculation is only an estimate. Invoicing will be done from the actual weight. Adjustments will be made accordingly.

Notre envoi sera envoyé à l'entrepôt le / Our shipment will be sent to the warehouse on:	
Nombre de morceaux / Total Pieces:	
Dimensions de la plus grosse unité / Size of largest piece:	Poids de la plus grosse unité / Weight of largest piece:
75,00\$/100 lbs. ≥ 50 lbs. 200 lbs (150,00\$ Minimum charge)	x 75,00\$
52,00\$ ≤ 50 lbs. Envoi / Shipment	x 52,00\$
99,50 \$ /100 lbs. Manutention spéciale/ Special handling (Minimum charge 199,00\$)	x 99,50\$
<p>Vous devez OBLIGATOIREMENT joindre le formulaire d'autorisation de carte de crédit à ce formulaire / The payment & credit card authorization form MUST accompany this form.</p> <p>Toutes les commandes sont soumises aux politiques de paiement et aux limites de responsabilités de GES Spécialiste mondial de l'événement stipulées dans ce manuel de l'exposant. / All orders are governed by the GES Global Experience Specialists Payment Policy and Limits of Liability & Responsibility as specified in this Exhibitor Kit.</p> <p>INDEMNITÉ D'ANNULATION: Après le début du montage de salon, toute annulation sera facturée à 50% du coût original et à 100% après la livraison. CANCELLATION CLAUSE: Items cancelled after move-in begins will be charged at 50% of the original price and 100% after installation.</p>	Montant / Amount
	R100992197 - TPS 5% GST
	1000169915 - TVQ 9.975% QST
	TOTAL
	COMPAGNIE - # STAND COMPANY - BOOTH #
<p>Faite parvenir votre commande par / Please send your order by: Télécopieur / Fax: 514-392-1577 ou Courriel / Email: clarkson@ges.com</p>	

UTILISEZ CES ÉTIQUETTES D'EXPÉDITION CAR ELLES VONT FACILITER LA MANUTENTION. Des copies de ces étiquettes sont acceptées si une quantité plus grande est nécessaire.
USE THESE SHIPPING LABELS AS THEY WILL EXPEDITE HANDLING. Copies of these labels are acceptable if additional labels are needed.

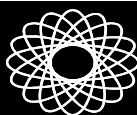

GES / *Spécialiste mondial de l'événement*

Clarkson-Conway

MATÉRIAUX D'EXPOSITION

EXPÉDITION DIRECTE AU SITE

À:

NOM DE LA COMPAGNIE

CANADIAN NEUROSCIENCE MEETING 2014

NOM DE L'EXPOSITION

NUMÉRO DE STAND

A/S (C/O) Débarcadère du Place Bonaventure
Coin St-Jacques & Montfort / Corner St-Montréal, QC, H5A 1G1

IMPORTANT! SVP VOUS RÉFÉREZ AUX HEURES D'INSTALLATION DANS CE CATALOGUE DES EXPOSANT

Transporteur

Nombre _____ de _____ morceaux



GES / *Spécialiste mondial de l'événement*

Clarkson-Conway

EXHIBITION FREIGHT

DIRECT SHIPMENT

TO:

COMPANY NAME

CANADIAN NEUROSCIENCE MEETING 2014

NAME OF EXHIBITION

BOOTH NUMBER

A/S (C/O) Débarcadère du Place Bonaventure
Coin St-Jacques & Montfort / Corner St-Montréal, QC, H5A 1G1

IMPORTANT! PLEASE REFER TO THE MOVE-IN DATES IN THIS EXHIBITOR'S KIT

Carrier

Number _____ of _____ pieces

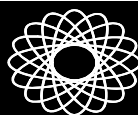

GES / *Spécialiste mondial de l'événement*

Clarkson-Conway

MATÉRIAUX D'EXPOSITION

EXPÉDITION DIRECTE AU SITE

À:

NOM DE LA COMPAGNIE

CANADIAN NEUROSCIENCE MEETING 2014

NOM DE L'EXPOSITION

NUMÉRO DE STAND

A/S (C/O) Débarcadère du Place Bonaventure
Coin St-Jacques & Montfort / Corner St-Montréal, QC, H5A 1G1

IMPORTANT! SVP VOUS RÉFÉREZ AUX HEURES D'INSTALLATION DANS CE CATALOGUE DES EXPOSANT

Transporteur

Nombre _____ de _____ morceaux



GES / *Spécialiste mondial de l'événement*

Clarkson-Conway

EXHIBITION FREIGHT

DIRECT SHIPMENT

TO:

COMPANY NAME

CANADIAN NEUROSCIENCE MEETING 2014

NAME OF EXHIBITION

BOOTH NUMBER

A/S (C/O) Débarcadère du Place Bonaventure
Coin St-Jacques & Montfort / Corner St-Montréal, QC, H5A 1G1

IMPORTANT! PLEASE REFER TO THE MOVE-IN DATES IN THIS EXHIBITOR'S KIT

Carrier

Number _____ of _____ pieces

CANADIAN NEUROSCIENCE MEETING 2014
MAY 26-28, 2014
HILTON MONTREAL BONAVENTURE, FONTAINE A-H

INFORMATION DE L'EXPÉDITEUR / SHIPPER INFORMATION

Nom de la compagnie / Company name:		
Adresse / Address		Ville / City:
Province / État / State:		
Téléphone / Phone:	Télécopieur / Fax:	Code postal / Postal code:
Personne ressource / Contact :		Courriel / Email:
Date de cueillette / Pick up date:		Heure de cueillette / Pick up time:
Heures d'affaire / Business hours:		Quai de déchargement / Loading dock
Courtier en douanes / Customs broker:		<input type="checkbox"/> Oui/ Yes <input type="checkbox"/> Non / No
J'expédie à l'entrepôt à l'avance / I will be shipping to the advance warehouse <input type="checkbox"/> Oui / Yes <input type="checkbox"/> Non / No		Documents de douanes ci-joints / Customs paperwork attached <input type="checkbox"/> Oui / Yes <input type="checkbox"/> Non / No

CONSIGNATAIRE / DESTINATION

Nom de l'exposition / Show name:	Lieu de l'exposition / Exhibition Facility:
Personne contact / Contact person:	Téléphone / Phone:
Date de livraison / Delivery date:	Heure de livraison / Delivery time:

SERVICE DEMANDÉ / REQUIRED SERVICE

<input type="checkbox"/> Aller-simple / One way	<input type="checkbox"/> Montage / Move-in	<input type="checkbox"/> Aller - retour / Round Trip
	<input type="checkbox"/> Démontage / Move-out	

ITEM À EXPÉDIER

Total de morceaux Total # of pieces	Dimensions	Poids estimé Estimated weight

Valeur déclarée / Declared value:	Poids total / Total weight
-----------------------------------	----------------------------

Signature de relâche / Release signature

Pour autoriser la livraison sans une signature

To authorize delivery without obtaining signature

COMPAGNIE / COMPANY

STAND / BOOTH

Toutes les commandes sont soumises aux politiques de paiement et aux limites de responsabilités de GES Spécialiste mondial de l'événement stipulées dans ce manuel de l'exposant.
All orders are governed by the GES Global Experience Specialists Payment Policy and Limits of Liability & Responsibility as specified in this Exhibitor Kit.
INDEMNITÉ D'ANNULATION: Après le début du montage de salon, toute annulation sera facturée à 50% du coût original et à 100% après la livraison.
CANCELLATION CLAUSE: Items cancelled after move-in begins will be charged at 50% of the original price and 100% after installation.

Faire parvenir votre commande par / Send your order by :
Télécopieur / Fax: 514-392-1577 ou Courriel / Email: clarkson@ges.com



GES

Spécialiste mondial de l'événement

Clarkson-Conway

Place Bonaventure
800 De la Gauchetière O.
bureau 1165
Montréal, QC, H5A 1K6
T. 514.861.9694
F. 514.392.1577
gesexpo.ca

Ameublement Furniture

Chaises / Chairs

0503



Chaise tissu gris
Side chair grey fabric

0504



Fauteuil tissu gris
Armchair grey fabric

0502-5



Fauteuil "Déco" noir
"Deco" armchair black

0502



Fauteuil aluminium
Aluminium armchair

Tabourets / Stools

0511



Tabouret champignon
Mushroom stool

0512



Tabouret de bar noir
Black bar stool

0512-Z



Tabouret chrome "Z"
"Z" chrome stool

0514



Tabouret tissu gris
High stool grey fabric

Tables / Tables

0521



Table à café
Coffee table 30" x 18"H

0523



Table
Table 30" x 30"H

0527 A30



Table carrée aluminium
Square aluminium table 24" x 30"H

0527 A40



Table ronde aluminium
Round aluminium table 24" x 43"H

0553
0551



Table avec jupe
Draped table 72" x 30" x 30"H
Table avec jupe
Draped table 48" x 30" x 30"H

Disponible 42" haut / Available 42" high



GES

Spécialiste mondial de l'événement

Clarkson-Conway

Place Bonaventure
800 De la Gauchetière O.
bureau 1165
Montréal, QC, H5A 1K6
T. 514.861.9694
F. 514.392.1577
gesexpo.ca

Comptoirs, présentoirs, divers Counters, displays, miscellaneous

Comptoirs, bureau / Counters, Desk

0614-06



Bureau
Desk 40" x 20" x 30" H

0651-CC-06



Comptoir courbé,
portes coulissantes
Curved counter with
sliding doors 40" x 32" x 40" H

0651-06



Comptoir, portes coulissantes
Counter with sliding doors 40" x 20" x 40" H

0650-06



Comptoir vitrine
Showcase counter 40" x 20" x 40" H

Présentoirs / Displays

0532



Chevalet
Tripod easel 61" H

0632-A



Porte affiche
Sign holder 60" H

0654-0



Présentoir vitrine
Showcase 40" x 20" x 80" H
20" de large aussi disponible / 20" wide also available

0621



Présentoir vitrine
Showcase 20" x 20" x 80" H
40" de large aussi disponible / 40" wide also available

Divers / Miscellaneous

0606-06



Boîte de tirage
Raffle Box 18,5" x 18,5" x 40" H

0661



Présentoirs
Display Units
Dimensions disponibles sur demande
Dimensions available upon request

0532-A



Support à brochure
Literature rack 9" x 55" H

CANADIAN NEUROSCIENCE MEETING 2014
MAY 26-28, 2014
HILTON MONTREAL BONAVENTURE, FONTAINE A-H

Date butoir pour prix escomptés: xxxxx
Deadline date for discount price: May 9th, 2014

LISTE DE PRIX / PRICE LIST

Qté/Qty	Code	Description Table recouverte de vinyle blanc & jupe sur 3 côtés, couleur de jupe:	\$ Escomptés Discount \$	\$ Régulier Regular \$	Total
Tables avec jupes Table / Skirted Tables					
	0551	Table de 4' de longueur avec jupe 30" (h) / Skirted 4' long table with 30" high skirt	85.70 \$	120.00 \$	
	0553	Table de 6' de longueur avec jupe 30" (h) / Skirted 6' long table with 30" high skirt	96.00 \$	134.00 \$	
	0541	Table de 4' de longueur avec jupe 42" (h) / Skirted 4' long table with 42" high skirt	114.00 \$	160.00 \$	
	0542	Table de 6' de longueur avec jupe 42" (h) / Skirted 6' long table with 42" high skirt	121.00 \$	169.00 \$	
	0549	Jupe 4e côté (optionnel) / 4th side skirted (optional)	27.00 \$	38.00 \$	

Noir - Black Bleu - Blue Vert - Green Rouge - Red Blanc - White Gris -Grey

Tables sans jupes (recouvert de vinyle seulement) / Un-skirted Tables (White Vinyl Top Only)

	0550	Table de 4' de longueur et 30" (h) / 4' long and 30" high table	52.00 \$	73.00 \$	
	0552	Table de 6' de longueur et 30" (h) / 6' long and 30" high table	57.50 \$	81.00 \$	
	0544	Table de 4' de longueur et 42" (h) / 4' long and 42" high table	68.00 \$	95.00 \$	
	0545	Table de 6' de longueur et 42" (h) / 6' long and 42" high table	71.50 \$	100.00 \$	

Tables

	0521	Table à café blanche 18" (h) / 18"H Round, White Coffee Table	63.50 \$	89.00 \$	
	0522	Table à café noire 18" (h) / 18"H Round, Black Coffee Table	63.50 \$	89.00 \$	
	0523	Table blanche 30"x30" (h) / 30"x30"H Round, White Table	88.00 \$	123.00 \$	
	0524	Table noire 30"x30" (h) / 30"x30"H Round, Black Table	88.00 \$	123.00 \$	
	0527-A-40	Table de cocktail 43" (h) / 43"H cocktail table	86.50 \$	121.00 \$	
	0527-A-30	Table carrée en aluminium 30" (h) / 30"H Aluminum square table	96.00 \$	134.00 \$	

Chaises / Chairs

	0502-A	Fauteuil aluminium / Aluminium Armchair	65.50 \$	92.00 \$	
	0502-5	Fauteuil déco noir / Black Deco Armchair	65.50 \$	92.00 \$	
	0503	Chaise de tissu gris (sans bras) / Grey Side Chair	43.00 \$	60.00 \$	
	0504	Fauteuil de tissu gris / Grey Arm Chair	53.00 \$	74.00 \$	
	0510	Chaise sténo / Steno Chair	65.00 \$	91.00 \$	
	0512	Tabouret de bar noir (sans dossier) / Black Bar Stool (no back)	43.00 \$	60.00 \$	
	0512-Z	Tabouret de Chrome "Z" / "Z" Chrome Stool	61.00 \$	85.00 \$	
	0514	Tabouret de tissu gris (avec dos) / Grey Stool (with back)	74.00 \$	104.00 \$	

Comptoirs / Counters

	0651-06	Comptoir blanc avec portes 40" x 20" x 40"H White counter with doors	244.00 \$	342.00 \$	
	0651-CC-06	Comptoir courbé blanc 40" x 32" x 40"H White curved counter	292.00 \$	409.00 \$	
	0650-06	Comptoir vitrine 40" x 20" x 40"H Showcase counter	274.00 \$	384.00 \$	

Toutes les commandes sont soumises aux politiques de paiement et aux limites de responsabilités de GES Spécialiste mondial de l'événement stipulées dans ce manuel de l'exposant. / All orders are governed by the GES Global Experience Specialists Payment Policy and Limits of Liability & Responsibility as specified in this Exhibitor Kit.
INDEMNITÉ D'ANNULATION: Après le début du montage de salon, toute annulation sera facturée à 50% du coût original et à 100% après la livraison.
CANCELLATION CLAUSE: Items cancelled after move-in begins will be charged at 50% of the original price and 100% after installation.

Montant / Amount \$

R100992197 - TPS 5% GST \$

1000169915 - TVQ 9.975% QST \$

TOTAL \$

COMPAGNIE / COMPANY

STAND \ BOOTH

Faite parvenir votre commande par / Send your order by :
Télécopieur / Fax: 514-392-1577 ou Courriel / Email: clarkson@ges.com

CANADIAN NEUROSCIENCE MEETING 2014
MAY 26-28, 2014
HILTON MONTREAL BONAVENTURE, FONTAINE A-H

Date butoir pour prix escomptés:

xxxxx

Deadline date for discount price:

May 9th, 2014

***** Avant de commander votre tapis, assurez-vous que la salle n'est pas déjà recouverte de tapis *****
Before ordering a carpet, please verify that the room is not already carpeted

LISTE DE PRIX / PRICE LIST

Qté/Qty	Code	Description	\$ Escomptés Discount \$	\$ Régulier Regular \$	Total
Tapis standard / Standard Carpet					
	0576	10' x 10' Tapis standard / Standard Carpet	183.00 \$	256.00 \$	
	0577	10' x 20' Tapis standard / Standard Carpet	366.00 \$	512.00 \$	
	0579	10' x 30' Tapis standard / Standard Carpet	549.00 \$	769.00 \$	
Tapis grandeur spéciale / Custom-Cut Carpet					
Le tapis de grandeur spéciale est requis, sans exception, pour tout espace plus long que 30' ou pour tout espace en îlot ou en péninsule. Custom-cut carpet is required for all booths larger than 30', or for booths configured as an island or peninsula. No Exceptions.					
	0578	_____ ' X _____ ' = _____ Pi.Ca/ Sq. Ft.	2.40 \$	3.00 \$	
Sous-tapis / Underpadding					
	0564-B	Sous-tapis 10' x 10' Under Padding	131.00 \$	183.00 \$	
	0564-B	Sous-tapis 10' x 20' Under Padding	264.00 \$	370.00 \$	
	0564-B	Sous-tapis 10' x 30' Under Padding	395.00 \$	553.00 \$	
	0564-B	_____ ' X _____ ' = _____ Pi.Ca/ Sq. Ft.	1.30 \$	2.00 \$	
Recouvrement de plastique / Plastic Covering for Protection					
	0564	_____ ' X _____ ' = _____ Pi.Ca/ Sq. Ft.	0.52 \$	1.00 \$	
Forfait Tapis (Inclut le tapis et le sous-tapis) / Carpet Package (Includes carpet and underpadding)					
	N/A	Forfait tapis 10' x 10' Carpet Package	274.50 \$	384.00 \$	
	N/A	Forfait tapis 10' x 20' Carpet Package	549.00 \$	769.00 \$	
	N/A	Forfait tapis 10' x 30' Carpet Package	823.50 \$	1,153.00 \$	
	N/A	_____ ' X _____ ' = _____ Pi.Ca/ Sq. Ft.	3.60 \$	5.00 \$	

Couleur de tapis / Colour Choice

- Gris / Grey Bourgogne / Burgundy Noir / Black
 Bleu / Blue Vert / Green Rouge / Red

Le gris sera la couleur choisie par défaut si aucun choix n'a été fait. Grey will be provided if no other colour choice has been made.

Toutes les commandes sont soumises aux politiques de paiement et aux limites de responsabilités de GES Spécialiste mondial de l'événement stipulées dans ce manuel de l'exposant. / All orders are governed by the GES Global Experience Specialists Payment Policy and Limits of Liability & Responsibility as specified in this Exhibitor Kit.
INDEMNITÉ D'ANNULATION: Après le début du montage de salon, toute annulation sera facturée à 50% du coût original et à 100% après la livraison.
CANCELLATION CLAUSE: Items cancelled after move-in begins will be charged at 50% of the original price and 100% after installation.

Montant / Amount	\$
R10092197 - TPS 5% GST	\$
1000169915 - TVQ 9.975% QST	\$
TOTAL	\$
COMPAGNIE / COMPANY	# STAND BOOTH #

Faite parvenir votre commande par / Send your order by :

CANADIAN NEUROSCIENCE MEETING 2014
MAY 26-28, 2014
HILTON MONTREAL BONAVENTURE, FONTAINE A-H

Date butoir pour prix escomptés
Deadline date for discount price

XXXXX
May 9th, 2014

LISTE DE PRIX / PRICE LIST					
Qté/Qty	Code	Description	\$ Escomptés Discount \$	\$ Régulier Regular \$	Total
Accessoires divers / General Accessories					
	0282	Projecteur ajustable sur tige noire 75 watts / 75 watt Black Arm-Clamp Spotlight	49.50 \$	69.00 \$	
	0532	Chevalet / Tripod Easel	45.00 \$	63.00 \$	
	0532-A	Présentoir à littérature / Literature Rack	102.00 \$	143.00 \$	
	0534	Corbeille à papier / Wastebasket	18.00 \$	25.00 \$	
	0533	Bac de recyclage / Recycling bin	18.00 \$	25.00 \$	
	0539	Porte manteaux en chrome / Chrome Garment Rack	80.00 \$	112.00 \$	
	0606	Boîte de tirage 20"x20"x40"H Raffle Box	114.00 \$	160.00 \$	
	0621	Présentoir Vitrine 20" x 20" x 80"H Showcase	433.50 \$	607.00 \$	
	0632-A	Porte affiche 60"h / 60"H sign holder	55.00 \$	77.00 \$	
	0654-0	Présentoir (ouverte sur 4 côtés) 40" x 20" x 80" H Showcase (open on 4 sides)	573.00 \$	802.00 \$	
	0661-40H	Cube 18" x 18" x 40"H cube (plus d'options (couleurs, dimensions) disponibles / More options (colours, size) available)	115.00 \$	161.00 \$	
	0693-4	Panneau d'affichage 4'x8' / 4'x8' Poster Panel	123.00 \$	172.00 \$	
	0694	Support pour sac / Bag holder	61.00 \$	85.00 \$	
<p>Toutes les commandes sont soumises aux politiques de paiement et aux limites de responsabilités de GES Spécialiste mondial de l'événement stipulées dans ce manuel de l'exposant. / All orders are governed by the GES Global Experience Specialists Payment Policy and Limits of Liability & Responsibility as specified in this Exhibitor Kit. INDEMNITÉ D'ANNULATION: Après le début du montage de salon, toute annulation sera facturée à 50% du coût original et à 100% après la livraison. CANCELLATION CLAUSE: Items cancelled after move-in begins will be charged at 50% of the original price and 100% after installation.</p>			Montant / Amount		\$
			R100992197 - TPS 5% GST		\$
			1000169915 - TVQ 9.975% QST		\$
			TOTAL		\$
			COMPAGNIE / COMPANY		
<p>Faite parvenir votre commande par / Send your order by : Télécopieur / Fax: 514-392-1577 ou Courriel / Email: clarkson@ges.com</p>					

CANADIAN NEUROSCIENCE MEETING 2014
MAY 26-28, 2014
HILTON MONTREAL BONAVENTURE, FONTAINE A-H

Date butoir pour prix escomptés:

XXXXX

Deadline date for discount price:

May 9th, 2014

LISTE DE PRIX / PRICE LIST

Qté/Qty	Code	Description	\$ Escomptés Discount \$	\$ Régulier Regular \$	Total
Accessoires pour panneaux du système modulaire / Accessories for panels from modular system					
	0681	Tablette en mélamine / Melamine Shelf <input type="checkbox"/> Droite/Straight <input type="checkbox"/> Inclinée / Angled	27.00 \$	38.00 \$	
	0687-C	Rail vestimentaire / Barre d'accrochage 1M (Cintre non-inclus) 1M wide Garment Rail / Hanging Bar (Hangers not included)	45.00 \$	63.00 \$	
	0689	Cascade avec six crochets / Waterfall with six hooks	36.00 \$	50.00 \$	
	0690	Pochette à littérature en plexiglass 8 1/2" X 12" Clear Plexi Literature Pock	31.50 \$	44.00 \$	
Panneaux muraux spéciaux / Special Wall Panels					
	1000-6	Panneau fibrex blanc 38 1/8" x 91"(H) White Fibrex Panel	103.50 \$	145.00 \$	
	1000-5	Panneau velcro 38 1/8" x 91" (H) Velcro Panel	103.50 \$	145.00 \$	
	1008	Panneau rainuré blanc 38 1/8" x 91"(H) White Slatwall Panel	152.50 \$	214.00 \$	
	1009	Panneau perforé blanc 38 1/8" x 85"(H) White pegboard Panel	116.00 \$	162.00 \$	

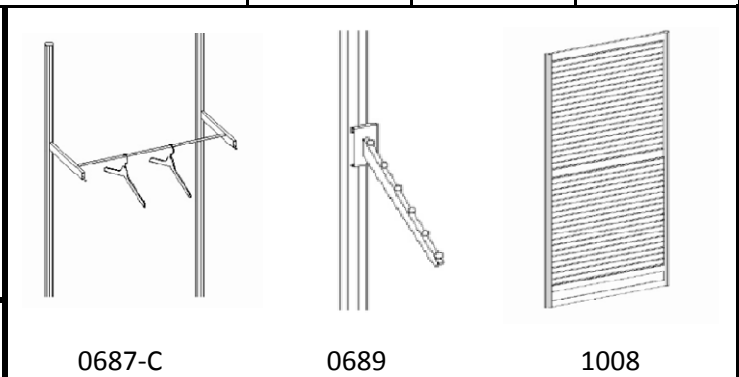
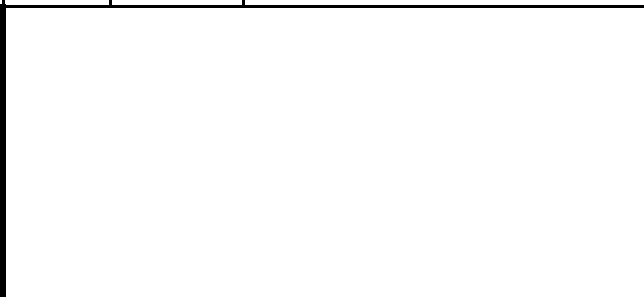

0687-C

0689

1008

Toutes les commandes sont soumises aux politiques de paiement et aux limites de responsabilités de GES Spécialiste mondial de l'événement stipulées dans ce manuel de l'exposant.

All orders are governed by the GES Global Experience Specialists Payment Policy and Limits of Liability & Responsibility as specified in this Exhibitor Kit.

INDEMNITÉ D'ANNULATION: Après le début du montage de salon, toute annulation sera facturée à 50% du coût original et à 100% après la livraison.

CANCELLATION CLAUSE: Items cancelled after move-in begins will be charged at 50% of the original price and 100% after installation.

Montant / Amount	\$
R100992197 - TPS 5% GST	\$
1000169915 - TVQ 9.975% QST	\$
TOTAL	\$
COMPAGNIE / COMPANY	STAND - BOOTH

Faite parvenir votre commande par / Send your order by :
Télécopieur / Fax: 514-392-1577 ou Courriel / Email: clarkson@ges.com

Fauteuil en cuir noir
Black leather tub chair



11A

CHB-WLT

Fauteuil en cuir blanc
White leather tub chair



Causeuse en tissu couleur charbon
Charcoal fabric loveseat



2B



2A

Fauteuil en tissu couleur charbon
Charcoal fabric chair

Chaise dossier haut - cuir noir / exécutive
High back executive swivel chair

7L



Chaise dossier bas - cuir noir / exécutive
Low back executive swivel chair

7G



Sofa « retro » en cuir noir
Retro black leather sofa 5000-E



5000-E

5001

Causeuse « retro » en cuir noir
Retro black leather loveseat



5002

Fauteuil « retro » en cuir noir
Retro black leather chair

Chaise en cuir blanc Bar celona
White Bar celona chair

BAR-CW

Chaise en cuir rouge Bar celona
Red Bar celona chair



BAR-CR

Pouffe en cuir blanc Bar celona
White Bar celona ottoman

BAR-OW





GES *Spécialiste mondial de l'événement*
Clarkson-Conway

Ameublement distinctif Specialty Furniture

Table de coin en verre fumé noir
Black wood smoked glass end table

Table à café en verre fumé noir
Black wood smoked glass top coffee table



CE-BTT

CE-BTE

Table de coin en verre fumé noir, base en métal chromé
Chrome metal smoked glass top end table

Table à café en verre fumé noir, base en métal chromé
Chrome metal smoked glass top coffee table



CE-BCT

CE-BCE

Tabouret en cuir noir
Black banana stool



SB

Tabouret noir dossier haut
Black fanback stool



SD



CE-ACG

Table de coin en verre, base en métal chromé,
hauteur ajustable

Adjustable height round table, glass/chrome

Table ronde bistro 30"
30" round bar table 5A



Table de conférence 42"
42" round meeting table 3A



3A

CE-GBW

Table à café en verre, base en bois
Coffee table, glass/black wood base





GES Spécialiste mondial de l'événement
Clarkson-Conway

AMEUBLEMENT DISTINCTIF SPECIALTY FURNITURE

CANADIAN NEUROSCIENCE MEETING 2014
MAY 26-28, 2014
HILTON MONTREAL BONAVENTURE, FONTAINE A-

Date butoir pour prix escomptés:
Deadline date for discount price:

XXXXX
May 9th, 2014

CET INVENTAIRE N'EST PAS GARANTI POUR LES COMMANDES PLACÉES APRÈS LA DATE BUTOIR
INVENTORY MAY NOT BE AVAILABLE FOR ORDERS PLACED AFTER THE DEADLINE DATE

LISTE DE PRIX / PRICE LIST

Qté Qty	Code	Description	\$ Escomptés Discount \$	\$ Régulier Regular \$	Total
	11A CHB-WLT	Fauteuil en cuir noir □ ou blanc □ / Black □ or white □ leather tub chair	126.50 \$	177.00 \$	
	2B	Causeuse en tissu couleur charbon / Charcoal fabric loveseat	184.00 \$	258.00 \$	
	2A	Fauteuil en tissu couleur charbon / Charcoal fabric chair	130.00 \$	182.00 \$	
	7L	Chaise exécutive, dossier haut en cuir noir / High back, black leather executive swivel chair	94.50 \$	132.00 \$	
	7G	Chaise exécutive, dossier bas en cuir noir / Low back, black leather executive swivel chair	79.50 \$	111.00 \$	
	5000-E	Sofa "retro" en cuir noir / Retro black leather sofa	385.00 \$	539.00 \$	
	5001	Causeuse "retro" en cuir noir / Retro black leather loveseat	274.00 \$	384.00 \$	
	5002	Fauteuil "retro" en cuir noir / Retro black leather chair	193.00 \$	270.00 \$	
	BAR- CR-CW-CB	Chaise en cuir rouge □ blanc □ noir □ Barcelona Red □ white □ black □ leather Barcelona chair	290.00 \$	406.00 \$	
	BAR- LR-LW-LB	Causeuse en cuir rouge □ blanc □ noir □ Barcelona Red □ white □ black □ leather Barcelona loveseat	531.50 \$	744.00 \$	
	BAR-OW	Pouffe en cuir blanc Barcelona / White leather Barcelona ottoman	161.00 \$	225.00 \$	
	TUB CHAIR	Chaise pivotante cuir blanc / Swivel white leather chair	126.50 \$	177.00 \$	
	CE-BTT	Table à café en verre fumé noir, base en bois noir / Black wood base, smoked glass top coffee table	105.00 \$	147.00 \$	
	CE-BTE	Table de coin en verre fumé noir, base en bois noir / Black wood base, smoked glass top end table	79.50 \$	111.00 \$	
	CE-BCT	Table à café en verre fumé noir, base en métal chromé / Chrome metal base, smoked glass top coffee table	105.00 \$	147.00 \$	
	CE-BCE	Table de coin en verre fumé noir, base en métal chromé / Chrome metal base, smoked glass top end table	85.00 \$	119.00 \$	
	5B	Tabouret en cuir noir / Black banana stool	90.00 \$	126.00 \$	
	5D	Tabouret noir dossier haut / Black leather fanback stool	52.00 \$	73.00 \$	
	CE-ACG	Table de coin rond en verre, base en métal chromé (hauteur ajustable) / Chrome metal base, glass top, round end table (adjustable height)	95.50 \$	134.00 \$	
	5A	Table rond bistro 30"d / 30"d round bar table	90.00 \$	126.00 \$	
	3A	Table de conférence 42"d / 42"d round meeting table	90.00 \$	126.00 \$	
	CE-GBW	Table à café en verre, base en bois / Coffee table, glass top, black wood base	192.00 \$	269.00 \$	

Toutes les commandes sont soumises aux politiques de paiement et aux limites de responsabilités de GES Spécialiste mondial de l'événement stipulées dans ce manuel de l'exposant. / All orders are governed by the GES Global Experience Specialists Payment Policy and Limits of Liability & Responsibility as specified in this Exhibitor Kit.
INDEMNITÉ D'ANNULATION: Après le début du montage de salon, toute annulation sera facturée à 50% du coût original et à 100% après la livraison.
CANCELLATION CLAUSE: Items cancelled after move-in begins will be charged at 50% of the original price and 100% after installation.

Montant / Amount \$

R100992197 - TPS 5% GST \$

1000169915 - TVQ 9.975% QST \$

TOTAL \$

COMPAGNIE / COMPANY

STAND
BOOTH #

Faite parvenir votre commande par / Send your order by :

CANADIAN NEUROSCIENCE MEETING 2014
MAY 26-28, 2014
HILTON MONTREAL BONAVENTURE, FONTAINE A-H

Date butoir pour prix escomptés: **XXXXX**
Deadline date for discount price: **May 9th, 2014**

Forfait spécial / GEM Show Special

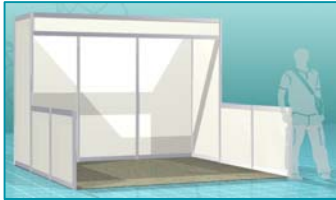

Inclut / Includes:

- Affiche d'identification (Lettrage noir) / Header sign (Black text)
- Rail de 3 projecteurs / 3 spot tracklight
- Corbeille à papier / Waste Paper Basket

Choix d'ameublement / Furniture Package Choice

- 1 Table 6'Long x 24"Large x 30"(H) (#0553) et 2 chaises (#0503) / 1 Skirted table 6'Lx24W"x30"H (#0553) and 2 side chairs (#0503) ET/OU
- 1 Comptoir blanc (#0651-06) et 1 tabouret (#0512) / 1 White Counter (#0651) and 1 bar stool (#0512)



Inclut / Includes:

- Affiche d'identification (Lettrage noir) / Header sign (Black text)
- Rail de 3 projecteurs / 3 spot tracklight
- Corbeille à papier / Waste Paper Basket

Choix d'ameublement / Furniture Package Choice

- 2 Tables 6'Long x 24"Large x 30"(H) (#0553) et 4 chaises (#0503) / 2 Skirted tables 6'Lx24W"x30"H (#0553) and 4 side chairs (#0503) ET/OU
- 2 Comptoirs blancs (#0651-06) et 2 tabourets (#0512) / 2 White Counters (#0651) and 2 bar stools (#0512)

Affiches d'identification / Header Sign (Logo = 75,00\$)



Texte complet / Complete Copy



Gauche / Left: _____

Droite / Right: _____

Choix de couleur de panneaux velcro

- Velcro Panel Colour Choice**
 Noir / Black Bleu / Blue

Choix de couleur de panneaux fibrex / Fibrex Panel Colour Choice

- Noir / Black Blanc / White Gris / Grey
 Cognac / Cognac Espresso / Espresso

\$ Escomptés / Discount \$	\$ Régulier / Regular \$	\$ Escomptés / Discount \$	\$ Régulier / Regular \$
914.00 \$	1,280.00 \$	1,938.00 \$	2,713.00 \$

Ce forfait n'inclut pas de tapis. Vérifiez si la salle est recouverte de tapis et référer au bon de commande de tapis pour en faire la location au besoin. vous

This package does not include carpet. Please verify if your room is carpeted and refer to the carpet order form if you need to place an order.

<p>Toutes les commandes sont soumises aux politiques de paiement et aux limites de responsabilités de GES Spécialiste mondial de l'événement stipulées dans ce manuel de l'exposant. / All orders are governed by the GES Global Experience Specialists Payment Policy and Limits of Liability & Responsibility as specified in this Exhibitor Kit. INDEMNITÉ D'ANNULATION: Après le début du montage de salon, toute annulation sera facturée à 50% du coût original et à 100% après la livraison. CANCELLATION CLAUSE: Items cancelled after move-in begins will be charged at 50% of the original price and 100% after installation.</p>	Montant / Amount	\$
	Logo (75,00\$)	\$
	R100992197 - TPS 5% GST	\$
	1000169915 - TVQ 9.975% QST	\$
	TOTAL	\$
	COMPAGNIE / COMPANY	STAND - BOOTH

Faite parvenir votre commande par / Send your order by :

Location de stand / Exhibit Rental

3 m x 3 m (10' x 10')

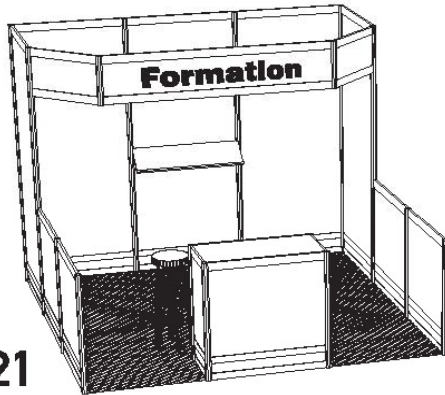

MB- 21

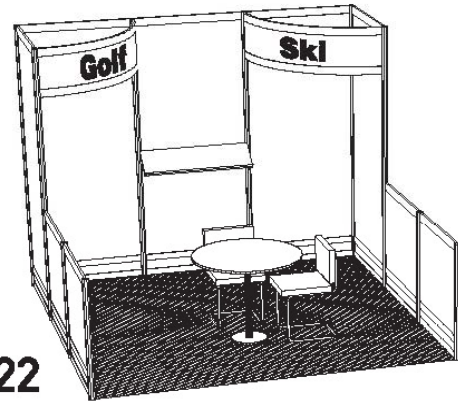

MB- 22

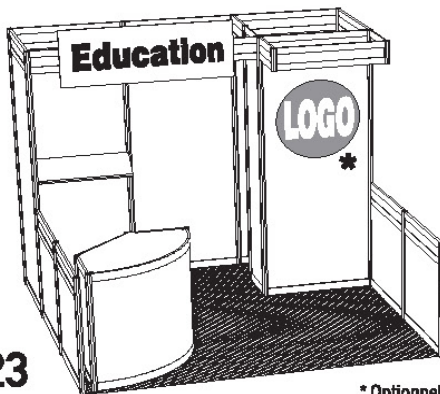

MB- 23

* Optionnel
Optional



MB- 24

* Optionnel
Optional

Choix de couleurs de panneaux / Choice of panels

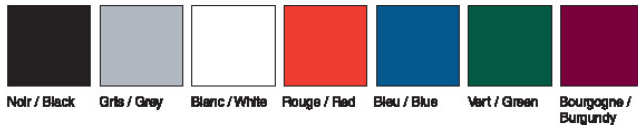

Noir / Black Gris / Grey Blanc / White Rouge / Red Bleu / Blue Vert / Green Bourgogne / Burgundy

Optionnel / Optional



Cognac / Cognac Espresso / Espresso Perforé / Pegboard Rainuré / Slatted



Clarkson-Conway

Place Bonaventure
800 De la Gauchetière O.
bureau 1165
Montréal, QC, H5A 1K6
T. 514.861.9694
F. 514.392.1577
gesexpo.ca

POUR COMMANDER: Complétez le formulaire « Location de stand »
TO ORDER: Complete the "Exhibit Rental Order Form"

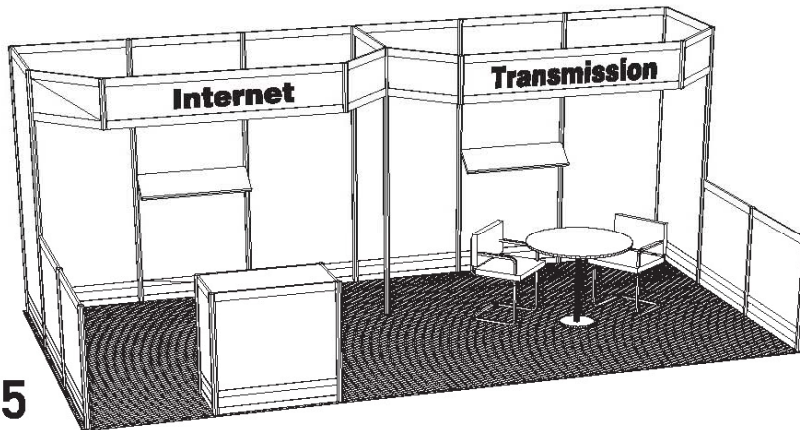

MB- 25

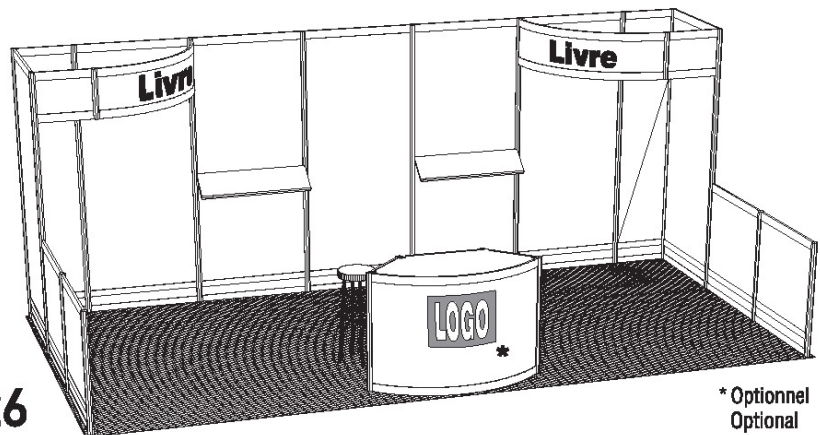

MB- 26

* Optionnel
Optional

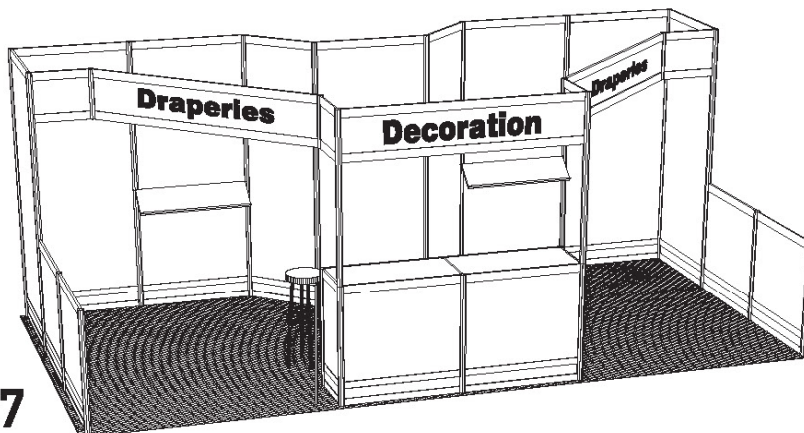

MB- 27



Place Bonaventure
800 De la Gauchetière O.
bureau 1165
Montréal, QC, H5A 1K6
T. 514.861.9694
F. 514.392.1577
gesexpo.ca

Location de stand / Exhibit Rental

3 m x 6 m (10' x 20')

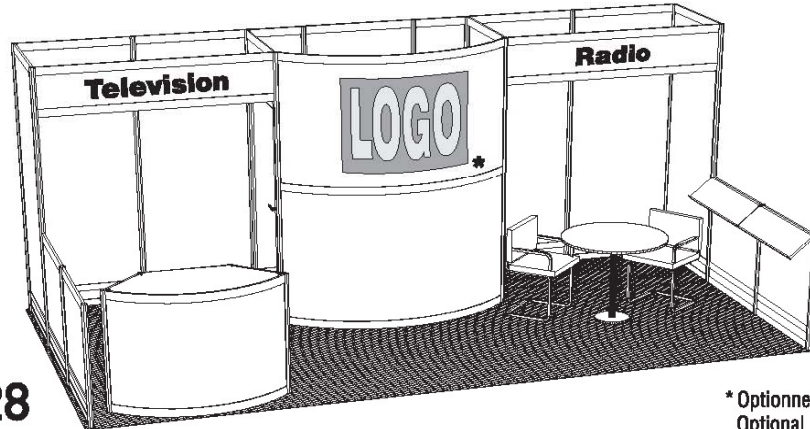

MB- 28

* Optionnel
Optional

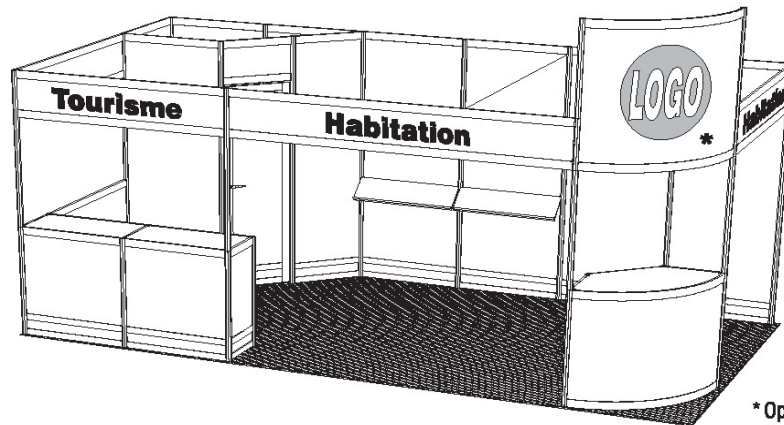

MB- 29

* Optionnel
Optional

Choix de couleurs de tapis
Choice of carpet colours



Clarkson-Conway

Place Bonav
800 De la Ga
bureau 1165
Montréal, Q
T. 514.861.9
F. 514.392.1
gesexpo.ca



GES Spécialiste mondial de l'événement
Clarkson-Conway

LOCATION STAND RIGIDE HARDWALL BOOTH RENTAL

CANADIAN NEUROSCIENCE MEETING 2014
MAY 26-28, 2014
HILTON MONTREAL BONAVENTURE,

Date butoir pour prix escomptés:
Deadline date for discount price:

xxxxx
May 9th, 2014

LISTE DE PRIX / PRICE LIST

Qté/Qty	Code	Description	\$ Escomptés Discount \$	\$ Régulier Regular \$	Total
	MB-21	10' x 10' - 1 comptoir, 2 tabourets, tapis, 1 tablette, 1 corbeille à papier et 1 rail de 3 projecteurs / 10' x 10' - 1 counter, 2 bar stools, carpet, 1 shelf, 1 waste basket and 1 3 spot tracklight	1,048.00 \$	1,467.00 \$	
	MB-22	10' x 10' - 1 table ronde, 2 chaises, tapis, 1 tablette, 1 corbeille à papier / 10' x 10' - 1 round table, 2 chairs, carpet, 1 shelf, 1 waste basket	1,137.50 \$	1,593.00 \$	
	MB-23	10' x 10' - 1 comptoir courbé, 1 tabouret, tapis, 1 tablette, 1 corbeille à papier, 1 rail de 3 projecteurs / 10' x 10' - 1 curved counter, 1 bar stool, carpet, 1 shelf, 1 waste basket, 1 3 spot tracklight	1,255.00 \$	1,757.00 \$	
	MB-24	10' x 10' - 1 comptoir courbé, 2 tabourets, tapis, 1 tablette, 1 corbeille à papier, 1 rail de 3 projecteurs / 10' x 10' - 1 curved counter, 2 bar stools, carpet, 1 shelf, 1 waste basket, 1 3 spot tracklight	1,372.00 \$	1,921.00 \$	
	MB-25	10' x 20' - 1 comptoir, 2 tabourets, 1 table ronde, 2 chaises, tapis, 2 tablettes, 1 corbeille à papier et 2 rail de 3 projecteurs / 10' x 20' - 1 counter, 2 bar stools, 1 round table, 2 chairs, carpet, 2 shelves, 1 waste basket and 2 x 3 spot tracklight	1,659.00 \$	2,323.00 \$	
	MB-26	10' x 20' - 1 comptoir courbé, 2 tabourets, tapis, 2 tablettes, 1 corbeille à papier et 2 projecteurs ajustables / 10' x 20' - 1 curved counter, 2 bar stools, carpet, 2 shelves, 1 waste basket and 2 adjustable spots	1,708.00 \$	2,391.00 \$	
	MB-27	10' x 20' - 2 comptoirs, 2 tabourets, tapis, 2 tablettes, 1 corbeille à papier et 2 rail de 3 projecteurs / 10' x 20' - 2 counters, 2 bar stools, carpet, 2 shelves, 1 waste basket and 2 x 3 spot tracklight	1,935.00 \$	2,709.00 \$	
	MB-28	10' x 20' - 1 comptoir courbé, 2 tabourets, 1 table ronde, 2 chaises, tapis, 2 tablettes, 1 corbeille à papier, 2 rail de 3 projecteurs / 10' x 20' - 1 curved counter, 2 bar stools, carpet, 1 round table, 2 chairs, 2 shelves, 1 waste basket, 2 x 3 spot tracklight	2,291.00 \$	3,207.00 \$	
	MB-29	10' x 20' - 2 comptoirs, 1 comptoir courbé, 2 tabourets, tapis, 2 tablettes, 1 corbeille à papier, 2 rail de 3 projecteurs / 10' x 20' - 2 counters, 1 curved counter, 2 bar stools, carpet, 2 shelves, 1 waste basket, 2 x 3 spot tracklight	2,524.00 \$	3,534.00 \$	

NOTES

Affiches d'identification / Header Signs

Couleur de tapis

Gris/Grey Rouge/Red Noir/Black

Couleur de texte - Enseigne

Noir / Black Rouge / Red
 Bleu / Blue Vert / Green

Choix de couleur de panneaux fibrex / Fibrex Panel Colour Choice

Noir / Black Blanc / White Cognac/ Cognac

Choix de couleur de panneaux velcro / Velcro Panel Colour Choice

Noir / Black Bleu / Blue Bourgogne / Burgundy Gris / Grey

Toutes les commandes sont soumises aux politiques de paiement et aux limites de responsabilités de GES Spécialiste mondial de l'événement stipulées dans ce manuel de l'exposant.

All orders are governed by the GES Global Experience Specialists Payment Policy and Limits of Liability & Responsibility as specified in this Exhibitor Kit.

INDEMNITÉ D'ANNULATION: Après le début du montage de salon, toute annulation sera facturée à 50% du coût original et à 100% après la livraison.

CANCELLATION CLAUSE: Items cancelled after move-in begins will be charged at 50% of the original price and 100% after installation.

Montant / Amount

\$

R100992197 - TPS 5% GST

\$

1000169915 - TVQ 9.975% QST

\$

TOTAL

COMPAGNIE / COMPANY

STAND / BOOTH

Faite parvenir votre commande par / Send your order by :
Télécopieur / Fax: 514-392-1577 ou Courriel / Email: clarkson@ges.com

CANADIAN NEUROSCIENCE MEETING 2014
MAY 26-28, 2014
HILTON MONTREAL BONAVENTURE, FONTAINE A-H

Date butoir pour prix escomptés: **XXXXX**
Deadline date for discount price: **May 9th, 2014**

LISTE DE PRIX / PRICE LIST

ASPIRATEUR ET POUBELLES / VACUUM AND GARBAGE CAN

Qté/Qty	Code	Description	\$ Escomptés Discount \$	\$ Régulier Regular \$	Total
Service de nettoyage journalier / Daily Cleaning Service					
	0150	Espace 10' x 10' booth space	57.50 \$	81.00 \$	
	0150	Espace 10' x 20' booth space	115.00 \$	161.00 \$	
	0150	Espace 10' x 30' booth space	172.50 \$	242.00 \$	
	0150	' x ' = _____ Pi.Ca. / Sq.FT	0.52 \$	1.00 \$	

**Les prix ci-dessus sont de frais journaliers.
Merci d'indiquer l'horaire désiré ci-dessous.**

**The above prices are daily charges.
Please indicate your requested cleaning schedule below.**

Jour \ Day	Heure \ Time



Toutes les commandes sont soumises aux politiques de paiement et aux limites de responsabilités de GES Spécialiste mondial de l'événement stipulées dans ce manuel de l'exposant.
All orders are governed by the GES Global Experience Specialists Payment Policy and Limits of Liability & Responsibility as specified in this Exhibitor Kit.
INDEMNITÉ D'ANNULATION: Après le début du montage de salon, toute annulation sera facturée à 50% du coût original et à 100% après la livraison.
CANCELLATION CLAUSE: Items cancelled after move-in begins will be charged at 50% of the original price and 100% after installation.

Montant / Amount	\$
R100992197 - TPS 5% GST	\$
1000169915 - TVQ 9.975% QST	\$
TOTAL	\$
COMPAGNIE / COMPANY	# STAND BOOTH #

CANADIAN NEUROSCIENCE MEETING 2014
MAY 26-28, 2014
HILTON MONTREAL BONAVENTURE, FONTAINE A-H

Date butoir pour prix escomptés: xxxxx
Deadline date for discount price: May 9th, 2014

LISTE DE PRIX / PRICE LIST

Qté/Qty	Code	Description	\$ Escomptés Discount \$	\$ Régulier Regular \$	Total
	0110	Plantes tropicales vertes / Green tropical plantes (3' - 5' haut/tall)	80.00 \$	112.00 \$	
	0110-A	Plantes tropicales vertes / Green tropical plantes (6' - 8' haut/tall)	109.00 \$	153.00 \$	
	0113	Fougère / Boston Fern	75.00 \$	105.00 \$	
	0111	Chrysanthème / Chrysanthemums	45.00 \$	63.00 \$	
	0112	Azalées / Azaleas	75.00 \$	105.00 \$	
	0114-A	Arrangement tropical / Tropical flower arrangement: Oiseaux de paradis, Lys orange, Roses oranges, Branche de Salix Torturosa, Verdures Exotiques Birds of Paradise, Tiger Lillies, Orange Roses, Curly Willow Branches, Exotic greens	211.00 \$	295.00 \$	
	0114-B	Arrangement Orchidée / Orchid Arrangement: Fleurs d'orchidées cymbidium, Orchidées Dandrobium, mousse verte, verdure variées Cymbidium and Dandrobium Orchids, Green Moss, Variety of Greens	121.00 \$	169.00 \$	
	0114-C	Arrangement branche de Cymbidium / Cymbidium Branch Arrangement: Branche cymbidium, branches Salix Torturosa, grosse feuille exotique dans pot en hauteur Cymbidium Orchid branch, Curly Willow branches, large exotic leaves in tall pot	211.00 \$	295.00 \$	
	0114-E	10 Lys Calla blanc / 10 Large White Calla Lilly: Lys Calla, branches, grosses feuilles exotiques dans un vase cylindrique White Calla Lily, Large exotic greens, Curly Willow branches in a cylinder vase	222.50 \$	312.00 \$	
	0114-F	Arrangement Protea / King Protea Arrangement: Protea au centre, Lys Calla en hauteur, Chrysanthème d'Hollande lime, verdure variée exotique. King Protea in middle, Yellow Calla, lime Holland Mums, Exotic greens.	155.00 \$	217.00 \$	
	0115	Arrangement de fleurs fraîchement coupées / Fresh cut flower arrangement	Valeur désirée Required Value		



0110

0110-A

0113

0114-A

0114-F

0114-B

Toutes les commandes sont soumises aux politiques de paiement et aux limites de responsabilités de GES Spécialiste mondial de l'événement stipulées dans ce manuel de l'exposant.
All orders are governed by the GES Global Experience Specialists Payment Policy and Limits of Liability & Responsibility as specified in this Exhibitor Kit.
INDEMNITÉ D'ANNULATION: Après le début du montage de salon, toute annulation sera facturée à 100% du coût original.
CANCELLATION CLAUSE: Items cancelled after move-in begins will be charged at 100% of the original price.

Montant / Amount	\$
R100992197 - TPS 5% GST	\$
1000169915 - TVQ 9.975% QST	\$
TOTAL	\$
COMPAGNIE / COMPANY	# STAND BOOTH #

Faite parvenir votre commande par / Send your order by :

CANADIAN NEUROSCIENCE MEETING 2014
MAY 26-28, 2014
HILTON MONTREAL BONAVENTURE, FONTAINE A-H

Date butoir pour prix escomptés **xxxxx**
Deadline date for discount price **May 9th, 2014**

LISTE DE PRIX / PRICE LIST

Qté/Qty	Code	Description	\$ Escomptés Discount \$	\$ Régulier Regular \$	Total
	206	Circuit 15 amps/120v - Circuit 15 amps/120v Positionné standard à l'arrière du stand - si positionnement autre voir ajout de frais supplémentaire. Positioning at the back of the booth - if other positioning add extra fee	50.00 \$		
	310	Services additionnels: Tout positionnement autre qu'à l'arrière du stand tels que fils en dessous du tapis, rallonge, prise du plafond, etc. Other electrical requirements: any positioning of power such as wire under the carpet, extension, outlet from ceiling, etc.	25.00 \$		

Services additionnels électriques sur demande / other electrical requirements available upon request

Autres services / Others services

		Rallonge électrique / Extension Cord	25.00\$		
		Power bar	25.00 \$		

Toutes les commandes sont soumises aux politiques de paiement et aux limites de responsabilités de GES Spécialiste mondial de l'événement stipulées dans ce manuel de l'exposant.

All orders are governed by the GES Global Experience Specialists Payment Policy and Limits of Liability & Responsibility as specified in this Exhibitor Kit.

INDEMNITÉ D'ANNULATION: Après le début du montage de salon, toute annulation sera facturée à 100% du coût original.

CANCELLATION CLAUSE: Items cancelled after move-in begins will be charged at 100% of the original price.

Montant / Amount	\$
R100992197 - TPS 5% GST	\$
1000169915 - TVQ 9.975% QST	\$
TOTAL	\$
COMPAGNIE / COMPANY	# STAND BOOTH #

CANADIAN NEUROSCIENCE MEETING 2014
MAY 26-28, 2014
HILTON MONTREAL BONAVENTURE, FONTAINE A-H

COMPAGNIE / COMPANY

STAND /
BOOTH #

RENSEIGNEMENTS IMPORTANTS ET TARIFS / IMPORTANT INFORMATION AND RATES

TARIFS HORAIRES / HOURLY RATES	HEURES / TIME	PAR OUVRIER / PER MAN
Temps régulier / Straight Time	Lundi au vendredi entre 08h00 et 16h00 / Between 8:00AM and 4:00 PM Weekdays	78.00 \$
Temps supplémentaire / Overtime	Avant 08h00 et entre 16h00 et 18h00 du lundi au vendredi; Entre 08h00 et 16h00 le samedi et dimanche. / Before 8:00AM and between 4:00PM and 6:00PM Weekdays; Between 8:00AM and 4:00PM Saturdays and Sundays	117.00 \$
Temps double / Double time	Après 18h00 du lundi au vendredi; Après 16h00 le samedi et dimanche et lors de congés fériés. / After 6:00PM Weekdays; After 4:00PM Saturdays and Sundays and on all holidays.	156.00 \$

Veillez indiquer le plan choisi / Please indicate service

AGISSEZ SANS LA PRÉSENCE DE L'EXPOSANT / GES SUPERVISED (OK TO PROCEED)

GES supervisera tout le travail effectué pour: / GES will supervise labour to:

- Déballer et installer le matériel d'exposition avant l'arrivée de l'exposant.
Unpack and install display before exhibitor arrival at showsite.
- Démonter et emballer le matériel à la fin du salon.
Dismantle and pack display after show closing.

Une surcharge de 25% (\$50.00 minimum) du total de la facture de main-d'œuvre sera ajoutée pour ce service additionnel. / A 25% (\$50.00 minimum) surcharge will be added to the labour rates above for the professional supervision.

Veillez cocher les cases appropriées / Please check off the appropriate boxes:

Photos / Photos - Directives ci-incluses - Set-up instructions attached

Dans la caisse / in crate ci-incluses / attached

SUPERVISÉE PAR L'EXPOSANT / EXHIBITOR SUPERVISED (DO NOT PROCEED)

Le travail est fait sous la supervision de l'exposant. / Exhibitor will supervise.

- L'heure du début des travaux ne peut être garantie que lorsque la main-d'œuvre est réservée pour le début de la journée (à compter de 8h00). / Starting time can only be guaranteed where labourers are requested for the start of the working day, which is 8:00am.
- L'exposant doit se présenter au comptoir de services pour prendre en charge les ouvriers réservés. et après que le travail soit terminée / The exhibitor representative has to check in at the service desk to pick up labourers ordered. The exhibitor representative also has to check labourers out at the service desk upon completion of the work.

GES ne sera pas responsable pour aucune perte ou dommage causé durant l'installation, le déballage, le démontage ou l'emballage du matériel de l'exposant. / GES will not be responsible for any loss or damage arising from the installation, unpacking, dismantling or packing of exhibitor property.

NOTES

Placez la commande ici / Place order here

	# d'ouvrier / # of labourers	Dates / Dates	Heure début / Start Time	Heure fin / End Time	Total d'heures / Total hours	Tarif / Rate	Total
Installation / Set-Up							
Démontage / Dismantle							

LES POURBOIRES, INCLUANT ARGENT COMPTANT OU HEURES POUR TRAVAIL NON-EFFECTUÉS NE SONT PAS PERMIS PAR GES Spécialiste mondial de l'événement. GES Spécialiste mondial de l'événement demande le plus haut niveau d'intégrité de tous ses employés. *GRATUITIES IN ANY FORM, INCLUDING CASH GIFTS, OR LABOUR HOURS FOR WORK NOT ACTUALLY PERFORMED ARE PROHIBITED BY GES Global Experience Specialists. GES Global Experience Specialists requires the highest standards of integrity from all employees.*

Toutes les commandes sont soumises aux politiques de paiement et aux limites de responsabilités de GES Spécialiste mondial de l'événement stipulées dans ce manuel de l'exposant.

All orders are governed by the GES Global Experience Specialists Payment Policy and Limits of Liability & Responsibility as specified in this Exhibitor Kit.

INDEMNITÉ D'ANNULATION: Après le début du montage de salon, toute annulation sera facturée à 50% du coût original et à 100% après la livraison.

CANCELLATION CLAUSE: Items cancelled after move-in begins will be charged at 50% of the original price and 100% after installation.

Montant / Amount

\$

*Surcharge de 25 % / 25% surcharge

R100992197 - TPS 5% GST

\$

1000169915 - TVQ 9.975% QST

\$

TOTAL

\$

Faite parvenir votre commande par / Send your order by :

Télécopieur / Fax: 514-392-1577 ou Courriel / Email: clarkson@ges.com

TERMS & CONDITIONS OF CONTRACT AND LIMITS OF LIABILITY & RESPONSIBILITY

I. Definitions:

Agents: GES Global Experience Specialists' agents, sub-contractors, carriers, and the agents of each.

Customer: Exhibitor or other party requesting services from GES Global Experience Specialists.

Carrier: Motor carrier, van line, air carrier, or air or surface carrier/ freight forwarder.

Shipper: Party who tenders Goods to Carrier for transportation.

Goods: Exhibits, property, and commodities of any type for which GES Global Experience Specialists is requested to perform services.

Cold Storage: Holding of Goods in a climate controlled area.

Accessible Storage: Holding of Goods in an area from which Goods may be removed during shows.

Services: Warehousing, transportation, drayage, un-supervised labour, supervised labour and/or related services.

Show Site: The venue or place where an exposition or event takes place.

Supervised Labour: Labour that is provided to a Customer to install or dismantle a booth or exhibit space, and is supervised and/or directed by GES Global Experience Specialists.

Un-Supervised Labour: Labour that is provided to a Customer to install or dismantle a booth or exhibit space and per Customer's election is not supervised and/or directed by GES Global Experience Specialists. Customer assumes the responsibility for the work of labour when Customer elects to use unsupervised labour.

II. Scope:

These Terms and Conditions shall be binding upon Customer, GES Global Experience Specialists, and their respective Agents and representatives, including but not limited to Customer contracted labour such as Customer Appointed Contractors and Installation and Dismantle Companies, and any other party with an interest in the Goods. Each shall have the benefit of and be bound by all provisions stated herein, including but not limited to time limits and limitations of liability.

By acceptance of services of GES Global Experience Specialists or Agents, Customer and any other party with an interest in the Goods agree to these Terms and Conditions.

III. Customer Obligations:

Payment for Services: Customer shall be liable for all unpaid charges for services performed by GES Global Experience Specialists or Agents. Customer authorizes GES Global Experience Specialists to charge it's credit card directly for services rendered on it's behalf after departure, by placing an order on-line, via fax, phone, or through a work order on site.

Credit Terms: All charges are due before Services are performed unless other arrangements have been made in advance. GES Global Experience Specialists has the right to require prepayment or guarantee of the charges at the time of request for Services. A failure to pay timely will result in Customer having to pay in cash in advance for future services. If a credit card is provided to GES Global Experience Specialists, GES Global Experience Specialists is authorized to bill to such credit card any unpaid charges for services provided Customer, including charges for return shipping. Any charges not paid within 30 days of delivery will be subject to interest at 1.5% per month until paid.

IV. Mutual Obligations:

Indemnification:

Customer to GES Global Experience Specialists: Except to the extent of GES Global Experience Specialists' own negligence and/or willful misconduct, Customer shall defend, hold harmless and indemnify GES Global Experience Specialists from and against any claims, lawsuits, demands, liability, costs, and expenses, including reasonable attorney's fees and court costs, resulting from any injury to or death of persons, or damage to property, relating to or arising from performance under this Agreement.

Customer agrees to indemnify and hold GES Global Experience Specialists harmless for any and all acts of its representatives and agents,

including but not limited to Customer Appointed Contractors and Installation and Dismantle Companies, any subtenant or other user of its' space or any agents or employees engaged in business on its' behalf of Customer or present at Customers' invitation.

GES Global Experience Specialists to Customer: To the extent of GES Global Experience Specialist's own negligence and/or willful misconduct, and subject to the limitations of liability below, GES Global Experience Specialists shall defend, hold harmless and indemnify Customer from and against any claims, lawsuits, demands, liability, costs and expenses, including reasonable attorney's fees and court costs, resulting from any injury to or death of persons, or damage to property other than Goods. GES Global Experience Specialists assumes no liability for bodily injury resulting from Customer's presence in areas which have been marked as "off limits to exhibitors" and during hours and days when exhibitors are present in the facility, prior to the start of and after the conclusion of their space lease with show management.

V. No liability for consequential damages. UNDER NO CIRCUMSTANCES WILL ANY PARTY BE LIABLE FOR SPECIAL, INCIDENTAL, CONSEQUENTIAL OR PUNITIVE DAMAGES, INCLUDING BUT NOT LIMITED TO LOSS OF PROFITS OR INCOME.

VI. GES Global Experience Specialists Liability for Loss or Damage to Goods

Negligence standard: GES Global Experience Specialists shall be liable, subject to the limitations contained herein, for loss or damage to Goods only if such loss or damage is caused by the direct negligence or willful misconduct of GES Global Experience Specialists.

Condition of Goods: GES Global Experience Specialists shall not be liable for damage, loss, or delay to uncrated freight, freight improperly packed, glass breakage or concealed damage. GES Global Experience Specialists shall not be liable for ordinary wear and tear in handling of Goods or for damage to shrink wrapped Goods. All Goods should be able to withstand handling by heavy equipment, including but not limited to forklifts, cranes, or dollies. It is the Customers' responsibility to ensure that Goods are packaged correctly prior to shipment or movement on or off the Show floor.

Receipt of Goods: GES Global Experience Specialists shall not be liable for Goods received without receipts, freight bills, or specified unit counts on receipts or freight bills. Such Goods shall be delivered to booth without the guarantee of piece count or condition.

Force Majeure: GES Global Experience Specialists shall not be liable for loss or damage that results from Acts of God, weather conditions, act or default of Customer, shipper, or the owner of the Goods, inherent nature of the Goods, public enemy, public authority, labour disputes, and acts of terrorism or war.

Cold Storage: Goods requiring cold storage are stored at Customer's own risk. GES Global Experience Specialists assumes no liability or responsibility for Cold Storage.

Accessible Storage: GES Global Experience Specialists assumes no liability for loss or damage to Goods while in Accessible Storage. Storage charges are for the use of space and are not a form of insurance, or a guarantee of security.

Unattended Goods: GES Global Experience Specialists assumes no liability for loss or damage to unattended Goods received at Show Site at any time from the point of receipt of inbound Goods until the loading of the outbound Goods, including the entire term of the respective show or exhibition. Customer is responsible for insuring it's own Goods for any and all risk of loss.

Labour: GES Global Experience Specialists assumes no liability for loss, damage, or bodily injury arising out of Customer's supervision of GES Global Experience Specialists provided labour. If GES Global Experience Specialists supervises labour for a fee, GES Global Experience Specialists shall be liable only for actions or claims arising out of its' negligent supervision. If Customer elects to use unsupervised labour, then Customer assumes all liability for the actions or claims that arise out of such work, and shall provide GES Global Experience Specialists and show management with an indemnity, including defense costs, for any claims that result from Customers' supervision or failure to supervise assigned labour.

TERMS & CONDITIONS OF CONTRACT AND LIMITS OF LIABILITY & RESPONSIBILITY

Empty Storage: GES Global Experience Specialists assumes no liability for loss or damage to Goods or crates, or the contents therein, while containers are in storage. It is the Customer's sole responsibility to affix the appropriate labels available at the GES Global Experience Specialists Servicentre for empty container storage. Damage that is the direct result of GES Global Experience Specialists' negligence shall be subject to the limitations of liability set forth in this document.

Forced Freight: GES Global Experience Specialists shall not be liable for Goods not picked up by Customer's chosen carrier by the show deadline. It is the Customer's responsibility to complete accurate paperwork for shipping and ensure its' Goods are appropriately labeled. Customer acknowledges that it is a lessee of space, and as such has an obligation to remove its' Goods on or before the targeted time. If Goods remain on the floor after this point, GES Global Experience Specialists has the right to remove them in order to restore the premises to its original condition for show management pursuant to the venue's lease with show management. In such cases GES Global Experience Specialists is authorized to proceed in the manner chosen by the Customer on the Order for Material Handling Services/ Straight Bill of Lading. Failure to select one of the provided options will result in re-routing at GES Global Experience Specialists' discretion, and at Customer's expense assuming the Goods are labeled for return. GES Global Experience Specialists retains the right to dispose of Goods left on the show floor without liability if left unattended, left without labels or not correctly labeled.

Concealed Damage: GES Global Experience Specialists shall not be liable for concealed loss or damage, uncrated Goods, or improperly package or labeled Goods.

Unattended Booth: GES Global Experience Specialists shall not be liable for any loss or damage occurring while Goods are unattended in Customer's booth at any time, including, but not limited to, the time the Goods are delivered to the dock until the time the Goods are received by Customer's chosen carrier. All Material Handling Forms and/or Straight Bills of Lading covering outgoing Goods submitted to GES Global Experience Specialists will be checked at the time of pickup from the booth and corrections to the count or condition will be documented where discrepancies exist.

Measure of Damage: GES Global Experience Specialists' liability shall be limited to the lesser of 1) the depreciated value of Goods, 2) repair cost, or 3) the limitation of liability. The limitation of liability shall be \$0.30 (thirty cents) per pound per piece, \$50 (fifty dollars) per article or \$1000.00 (one thousand dollars) per shipment.

No Insurance: GES Global Experience Specialists is not an insurance company and does not offer or provide insurance. It is the obligation of Customer to ensure Goods are insured at all times. Loss or theft of the Goods in storage or in transit to and from the show and or while on the show floor is the sole responsibility of Customer, unless it is shown that GES Global Experience Specialists performed in a manner that constitutes gross negligence in the performance of its services for Customer.

Notice of loss or damage: In order to have a valid claim, notice of loss or damage to Goods must be given to GES Global Experience Specialists within 24 hours of occurrence or delivery of Goods, whichever is later.

Filing of Claim: Any claim for loss or damage to Goods must be in writing, containing facts sufficient to identify the Goods, asserting liability for alleged loss or damage, and making claim for the payment of a specified or determinable amount of money. Such claim must be filed with the appropriate party within the time limits specified below.

Damage Reports, incident reports, inspection reports, notations of shortage or damage on freight bills or other documents, do not constitute filing of a claim.

Claim for goods alleged to be lost, stolen or damaged at the Show Site must be received in writing by GES Global Experience Specialists within sixty (60) days after the close of the show.

Claims for Goods alleged to be lost or damaged during transit must be received by the responsible party within nine (9) months of the date of delivery of Goods. GES Global Experience Specialists Logistics subcontracts the movement of Goods to third party carriers. Claims for damage in transit should be made directly with the Customer's carrier as shown on the Material Handling form / Straight Bill of Lading. In the event of a dispute with GES Global Experience Specialists, Customer will not withhold payment or any amount due GES Global Experience Specialist for Services as an offset against the amount of the alleged loss or damage. Customer agrees to pay GES Global Experience Specialists prior to the close of the show for all such charges and further agrees that any claim Customer may have against GES Global Experience Specialists shall be pursued independently by Customer as a separate action to be resolved on its own merits. GES Global Experience Specialists reserves the right to pursue collection on amounts owed after show close, without regard to any amount alleged to be owed for damage, or loss.

Filing of Suit: Any action at law regarding loss or damage to Goods must be filed within one (1) year of the date of declination of any part of a claim.

VII. Jurisdiction, Choice of Forum.

This Agreement shall be governed by and construed in accordance with the applicable laws of Canada or, alternatively, and depending on jurisdiction, the laws of the Province of Quebec.

VIII. Advance Warehousing / Temporary Storage / Long Term Storage.

All terms and conditions relative to Advanced Warehousing / Temporary Storage / Long Term Storage are contained in the separate agreement entitled "Storage Agreement". In the event that a Storage Agreement is not executed between the parties, the following shall apply with respect to GES Global Experience Specialists' liability for Customer's Goods:

The responsibility of GES Global Experience Specialists with respect to Exhibit Material is limited to the exercise of ordinary care and diligence in handling and storing of Customer's Goods. GES Global Experience Specialists shall be liable only for loss or damage to Goods caused by GES Global Experience Specialists' sole negligence. GES Global Experience Specialists' liability is limited to sixty (\$0.60) cents per pound or the actual cash value per article. In the case of partial loss or damage, the maximum liability shall be prorated based on weight. GES Global Experience Specialists is not responsible for any loss or damage to Goods caused by, but not limited to fire, theft, the elements, vandalism, moisture, vermin, mechanical breakdown or failure, freezing or changes in temperature, as well as any other causes beyond GES Global Experience Specialists' immediate control. GES Global Experience Specialists is not responsible for the marring, scratching, or breakage of glass or other fragile items. GES Global Experience Specialists is not liable for the mechanical functions of instruments or appliances even if such articles are packed or unpacked by GES Global Experience Specialists. In no event shall GES Global Experience Specialists be liable for special, incidental, indirect, or consequential damages, including business loss of any kind, resulting from any damage to or loss of Goods or from any act or failure to act. Customer pays storage fees, if any or costs for advance warehousing for use of the space only. There is no guarantee of security or representations made by GES Global Experience Specialists as to appropriateness of the conditions for Exhibitors' Material. This risk of loss remains the Customer's alone and GES Global Experience Specialists recommends the Customer carry and maintain insurance in amounts sufficient to cover its risk.

SPECIAL NOTE: THE CONSIGNMENT OR DELIVERY OF A SHIPMENT TO GES CANADA OR ITS SUBCONTRACTORS BY A CUSTOMER OR BY ANY SHIPPER ON BEHALF OF THE CUSTOMER SHALL BE CONSTRUED AS AN ACCEPTANCE BY SUCH EXHIBITOR (AND/OR OTHER SHIPPER) OF THE TERMS AND CONDITIONS SET FORTH IN THIS AGREEMENT.

La sécurité est très importante pour toutes les personnes qui travaillent dans la salle d'exposition – surtout la vôtre !

GES Spécialiste mondial de l'événement est engagé à la sécurité au niveau de la compagnie et à travers les fonctions que nous effectuons. Nous vous demandons de prioriser la sécurité lors de vos activités pendant l'évènement. Si vous êtes témoin d'une action qui représente un danger, veuillez s.v.p. la rapporter à un superviseur de GES Spécialiste mondial de l'événement. En témoignant des actions non-sécuritaires, vous aiderez à rendre l'évènement plus sécuritaire et agréable pour vous et vos confrères exposants.

Veuillez vous référer et respecter la liste des conseils de prévention de pertes que vous trouverez ci-dessous. Ces directives aideront à améliorer la sécurité de l'évènement en général et de prévenir des blessures aux exposants, aux employés et à vous. Amusez-vous et faites-le en toute sécurité ! Merci de votre collaboration !

Guide de conseils de prévention de perte pour les exposants sur le site de l'évènement.

- Il est strictement interdit de fumer dans le hall d'exposition.
- Il est INTERDIT de monter debout sur les chaises, tables ou tout autre mobilier. Veuillez utiliser une échelle ou demander de l'aide auprès du personnel de GES Spécialiste mondial de l'évènement
- Seuls les employés autorisés de GES Spécialiste mondial de l'évènement ont l'autorisation d'opérer les chariots élévateurs ainsi que les transpalettes. Demandez de l'aide.
- Faites attention aux chariots élévateurs qui circulent dans les allées et sur les débarcadères. Veuillez s.v.p. vous tenir loin de ces appareils, surtout lorsqu'ils transportent une charge ou une palette.
- Ne jamais courir dans le hall d'exposition. S.V.P. veuillez marcher. Attention où vous mettez les pieds dans les allées et restez loin des débarcadères.
- Les fils électriques ainsi que les extensions peuvent être dangereux s'ils sont effilochés ou étirés dans une allée. S.V.P. veuillez vérifier l'état des fils. Pour toute assistance ou pour remplacer un fil endommagé, veuillez aviser le responsable des services électriques. Ne pas surcharger les prises électriques.
- S.V.P. veuillez garder les sorties de feu dégagées. Si vous êtes témoin d'un feu, veuillez le signaler immédiatement ou actionner l'alarme de feu le plus près.
- Si vous renversez quelque chose, ou apercevez un liquide renversé, veuillez le signaler immédiatement.
- Gardez votre espace propre. Jetez les débris et disposez votre matériel de façon sécuritaire.
- Les allées doivent restées propres et sans débris.
- Assurez-vous que vos effets de grandes valeurs sont placés dans un endroit sécuritaire dans le hall d'exposition. Les articles laissés sans supervision dans les kiosques, peuvent être des cibles pour le vol.

Safety is very important for everyone working in the exhibit hall - especially you!

GES Global Experience Specialists is committed to safety throughout our company and in the work that we do. We request that you make safety a part of your activities during the show. If you see something unsafe or that presents a hazard, please bring it to the attention of a GES Global Experience Specialists supervisor. By reporting unsafe or hazardous conditions, you will help make the show safer and more enjoyable for yourself and your fellow exhibitors.

Below you will find a list of Loss Prevention Guidelines that we request you follow while at showsite. These Guidelines will enhance the overall safety of the show and help to prevent injuries to you, our employees, and other exhibitors. Enjoy the show safely. Thank you for your cooperation!

Exhibitor loss prevention guidelines at showsite

- Smoking is prohibited in the exhibit venue.
- Standing on chairs, tables, and other furniture is PROHIBITED. The furniture is not designed to support your standing weight. Please use a ladder or ask GES Global Experience Specialists personnel for assistance.
- Forklifts and pallet jacks are to be used by authorized GES Global Experience Specialists personnel only. Please do not operate this equipment. Ask for help.
- Be aware of the forklifts moving throughout the aisles and docks. Please stay clear of them, especially when they are carrying a crate or load.
- Never run in the exhibit hall. Please walk. Watch your step in the aisles and stay away from the loading docks.
- Electrical wires and cords can be hazardous if frayed or stretched over a walkway. Please check all cords for damage. Notify the electrical service company if you need assistance repairing or removing a damaged cord. Do not overload outlets or plugs.
- Please keep fire exits clear. Report any fires immediately or pull the nearest fire alarm.
- If you spill something, or notice a spill, clean it up or report it immediately. Please do not walk away from a spill.
- Apply good housekeeping. Dispose of any waste properly and keep materials stacked securely.
- Keep aisles free and clear of any and all debris.
- Protect your valuables while on the show floor. Please keep all expensive or valuable items secured. Unattended items in booths are easy theft targets.
- Notify a GES Global Experience Specialists representative of any safety issues or concerns.

Order Form

Customs and
Transportation Services



The original of this form must be completed to ensure Customs Clearance.
Please accept this as your authority for Customs Clearance and / or Transportation Services.

We wish to use Mendelssohn Event Logistics services for: (please check one)

- Customs Clearance and Transportation (Shipment Order Form Required) Customs Clearance Only Transportation Only (Shipment Order Form Required)

Section 1 Exhibitor and Shipment Information

Exhibitor / Company Name:

U.S. Tax # or U.S. IRS Identification:

Event Name:

Facility Name:

Event Date/s:

Booth #:

Shipment Date:

From (City, State):

Carrier Name:

It Consists Of (# of Cartons, etc.):

Weight: lbs kgs

Rep At The Event:

E-Mail:

Cell Phone Number:

Please do not ship via post or parcel courier – we will not be responsible for timely delivery

Section 2 Return Shipment Consignment Information

Company Name:

Address:

City:

Province / State:

Postal/Zip:

Name:

Tel:

Fax:

Ship Via: Common Carrier Our Company Vehicle Van Line Service Air Freight Service

Section 3 Terms of Payment and Security Deposit (Must be completed)

Credit Card Information must be completed

Charge to: Visa MasterCard American Express

Cardholder Name:

Title:

Card Account Number:

Expiry Date:

Cardholder's Signature: _____

I hereby authorize the use of this credit card for payment of services relative to this order form.

Alternative methods of payment are bank wire transfer or pre-payment on credit card (Receipt 10 days prior to event).

****NOTE: A 2% administrative fee (minimum \$25.00) will be charged for all credit card declines.**

Section 4 Invoicing/Statement Information

Company Name:

Address:

City:

Province/State:

Postal/Zip:

Name:

Tel:

Fax:

This document was completed by (Please print full name):

Title:

Date:

Order Form

Customs and
Transportation Services

MENDELSSOHN EVENT LOGISTICS

The original of this form must be completed to ensure Customs Clearance.
Please accept this as your authority for Customs Clearance and / or Transportation Services.

We wish to use Mendelssohn Event Logistics services for: (please check one)

- Customs Clearance and Transportation (Shipment Order Form Required) Customs Clearance Only Transportation Only (Shipment Order Form Required)

Section 1 Exhibitor and Shipment Information

Exhibitor / Company Name: ABC Distributing Company
U.S. Tax # or U.S. IRS Identification: 10-9999999
Event Name: International Computing Event
Facility Name: Event Facility Event Date/s: Apr 14/07 - Apr 17/07 Booth #: 234
Shipment Date: Apr 3/07 From (City, State): Chicago, IL Carrier Name: Mendelssohn Event Logistics
It Consists Of (# of Cartons, etc.): 11 Weight: 300 lbs kgs
Rep At The Event: Joe Smith E-Mail: jsmith@domain.com Cell Phone Number: 416-555-1234

Please do not ship via post or parcel courier – we will not be responsible for timely delivery

Section 2 Return Shipment Consignment Information

Company Name: ABC Distributing Company
Address: 125 Elm Street
City: Chicago Province / State: IL Postal/Zip: 66666-6666
Name: Sandy Smith Tel: 708-555-1212 Fax: 708-555-2222
Ship Via: Common Carrier Our Company Vehicle Van Line Service Air Freight Service

Section 3 Terms of Payment and Security Deposit (Must be completed)

Credit Card Information must be completed

Charge to: Visa MasterCard American Express

Cardholder Name: Joe Smith Title: Accounting Manager

Card Account Number: 123456789012 Expiry Date: 12/09

Cardholder's Signature: Joe Smith

I hereby authorize the use of this credit card for payment of services relative to this order form.
Alternative methods of payment are bank wire transfer or pre-payment on credit card (Receipt 10 days prior to event).

**NOTE: A 2% administrative fee (minimum \$25.00) will be charged for all credit card declines.

Section 4 Invoicing/Statement Information

Company Name: ABC Distributing Company
Address: 125 Elm Street
City: Chicago Province/State: IL Postal/Zip: 66666-6666
Name: Joe Smith Tel: 708-555-1200 Fax: 708-555-1201
This document was completed by (Please print full name): Joe Smith
Title: Accounting Manager Date: March 14, 2007



CANADA CUSTOMS INVOICE / FACTURE DES DOUANES CANADIENNES

<p>1 Vendor (Name and Address) / Vendeur (Nom et Adresse)</p>	<p>2 Date of Direct Shipment to Canada Date d'expédition directe vers le Canada</p> <p>3 Other References (Include Purchaser's Order No.) Autres références (inclure le no de commande de l'acheteur)</p>
<p>4 Consignee (Name and Address) / Destinataire (Nom et Adresse)</p>	<p>5 Purchaser's Name and Address (if other than Consignee) Nom et Adresse de l'acheteur (s'il diffère du destinataire) No sale involved</p> <p>6 Country of Transshipment / Pays de transbordement N/A</p> <p>7 Country of Origin of Goods Pays d'origine des marchandises</p> <p style="font-size: small;">If shipment includes goods of different origins, enter origins against items in field 12. Si l'expédition comprend des marchandises d'origines différentes, en préciser la provenance en 12.</p>
<p>VII. 1 Is this a related company transaction? Est-ce que les compagnies sont liées entre elles?</p> <p style="text-align: center;">YES <input type="checkbox"/> OUI NO <input checked="" type="checkbox"/> NON</p>	<p>9 Condition of Sales and Terms of Payment (i.e. Sale, Consignment Shipment, Leased Goods, etc.) Conditions de vente et modalités de paiement (p. Ex. Vente, Expédition en consignation, location de marchandises, etc.) No sale involved</p>
<p>8 Transportation: Give Mode and Place of Direct Shipment to Canada Transport: Préciser mode et lieu d'expédition directe vers le Canada</p>	<p>10 Currency of Settlement / Devises du paiement</p>

11	No. of Pkgs. Nbre. De Colis	12	Specification of Commodities (Kind of Packages Marks and Numbers, General Description and Characteristics i.e. Grade Quality) Designation des articles (Nature des colis, marques et numéros, description générale et caractéristiques. P. Ex. Classe, qualité)	13	Quantity (State Unit) Quantité (Préciser l'unité)	Replacement Value Valeur de Remplacement			
						14	Unit Price Prix Unitaire	15	Total

<p>XI.1 Total Number of Pieces / Nombre total de pièces</p>	<p>16 Total Weight / Poids total</p>	<p>17 Invoice Total Total de la facture</p>
<p>18 If any fields of 1 to 17 are included on an attached commercial invoice, check this box Si les renseignements des zones 1 à 17 figurent sur la facture commerciale cocher cette case</p> <p>Commercial Invoice No. / No. De la facture commerciale _____ <input type="checkbox"/></p>	<p>Net N/A</p>	<p>Gross / Brut</p>

<p>19 Exporter's Name and Address (if other than Vendor) Nom et adresse de l'exportateur (s'il diffère du vendeur)</p> <p style="text-align: center;">Name: Tel: Fax:</p>	<p>20 Originator (Name and Address) Expéditeur d'origine (Nom et adresse)</p> <p style="text-align: center;">Name: Tel: Fax:</p>
---	--

<p>21 Departmental Ruling (if applicable) Décision ministérielle (s'il y a lieu) N/A</p>	<p>22 If fields 23 to 25 are not applicable, check this box Si les zones 23 à 25 sont sans objet, cocher cette case <input checked="" type="checkbox"/></p>	
<p>23</p>	<p>24</p>	<p>25</p>



CANADA CUSTOMS INVOICE / FACTURE DES DOUANNES CANADIENNES

<p>1 Vendor (Name and Address) / Vendeur (Nom et Adresse)</p> <p>ABC Distributing Company 125 Elm Street Chicago, IL 66666-6666</p>	<p>2 Date of Direct Shipment to Canada / Date d'expédition directe vers le Canada 4/3/2007</p> <p>3 Other References (Include Purchaser's Order No.) / Autres références (inclure le no de commande de l'acheteur) 10-9999999</p>
<p>4 Consignee (Name and Address) / Destinataire (Nom et Adresse)</p> <p>ABC Distributing Company / Booth 234 International Computing Event c/o Event Facility 100 Anywhere Street Toronto, ON M7W 2P6</p>	<p>5 Purchaser's Name and Address (if other than Consignee) / Nom et Adresse de l'acheteur (s'il diffère du destinataire) No sale involved</p> <p>6 Country of Transshipment / Pays de transbordement N/A</p>
<p>VII. 1 Is this a related company transaction? / Est-ce que les compagnies sont liées entre elles? YES <input type="checkbox"/> OUI NO <input checked="" type="checkbox"/> NON</p>	<p>7 Country of Origin of Goods / Pays d'origine des marchandises USA</p> <p style="font-size: small;">If shipment includes goods of different origins, enter origins against items in field 12. / Si l'expédition comprend des marchandises d'origines différentes, en préciser la provenance en 12.</p>
<p>8 Transportation: Give Mode and Place of Direct Shipment to Canada / Transport: Préciser mode et lieu d'expédition directe vers le Canada Mendelssohn Event Logistics, Chicago, IL</p>	<p>9 Condition of Sales and Terms of Payment (i.e. Sale, Consignment Shipment, Leased Goods, etc.) / Conditions de vente et modalités de paiement (p. Ex. Vente, Expédition en consignation, location de marchandises, etc.) No sale involved</p> <p>10 Currency of Settlement / Devises du paiement USD</p>

11 No. of Pkgs. Nmbre. De Coills	12 Specification of Commodities (Kind of Packages Marks and Numbers, General Description and Characteristics i.e. Grade Quality) / Designation des articles (Nature des colis, marques et numéros, description générale et caractéristiques. P. Ex. Classe, qualité)	13 Quantity (State Unit) / Quantité (Préciser l'unité)	14 Unit Price / Prix Unitaire	15 Total
2 pcs	Wooden Crates - Display Booth (backwalls, lights, graphics, carpets)	1	\$5000.00	\$5000.00
2 pcs	Cartons - Advertising Brochures / Catalogs / Technical Literature	1000	\$0.10	\$100.00
1 pc	Carton - Plastic Key Chains	50	\$0.50	\$25.00
1 pc	Carton - Books	50	\$1.00	\$50.00
3 pcs	Crates - Computers	3	\$1000.00	\$1000.00
2 pcs	Crates - Computer Monitors	2	\$500.00	\$1000.00

<p>XI.1 Total Number of Pieces / Nombre total de pièces 11</p>		
<p>18 If any fields of 1 to 17 are included on an attached commercial invoice, check this box / Si les renseignements des zones 1 à 17 figurent sur la facture commerciale cocher cette case</p> <p>Commercial Invoice No. / No. De la facture commerciale _____ <input type="checkbox"/></p>	<p>16 Total Weight / Poids total</p> <p>Net N/A</p> <p>Gross / Brut 300 lbs</p>	<p>17 Invoice Total / Total de la facture \$7,175.00</p>

<p>19 Exporter's Name and Address (if other than Vendor) / Nom et adresse de l'exportateur (s'il diffère du vendeur)</p> <p>Name: _____ Tel: _____ Fax: _____</p>	<p>20 Originator (Name and Address) / Expéditeur d'origine (Nome et adresse)</p> <p>ABC Distributing Company Name: Joe Smith 125 Elm Street Tel: 708-555-1212 Chicago, IL Fax: 708-555-1201 66666-6666</p>
---	--

<p>21 Departmental Ruling (if applicable) / Décision ministérielle (s'il y a lieu) N/A</p>	<p>22 If fields 23 to 25 are not applicable, check this box / Si les zones 23 à 25 sont sans objet, cocher cette case <input checked="" type="checkbox"/></p>	
23	24	25

Shipment Order Form

Customs and
Transportation Services

Tel: (514)987-2700
Toll Free: (800)665-4628
Fax: (514)849-3446

MENDELSSOHN EVENT LOGISTICS

To obtain a quotation for Mendelssohn Event Logistics Transportation Services, please complete this form and fax to (514)849-3446.

Section 1 Pick-Up Information

Shipper: _____
Address: _____
City: _____ State: _____ Zip: _____
Contact: _____ Tel: _____ Fax: _____
Hours of Operation: _____ Dock: Yes No Lift Gate Required: Yes No
Inside Pick-Up: Yes No Pick-Up Date: _____ To Arrive By: _____

Section 2 Freight Information

COMMODITY: Exhibit Related Articles

# of Pieces	Box/Crate/etc.	Length	Width	Height	Per Piece
	@ Dimensions Each:				@ Weight Each:
	@ Dimensions Each:				@ Weight Each:
	@ Dimensions Each:				@ Weight Each:
	@ Dimensions Each:				@ Weight Each:
	@ Dimensions Each:				@ Weight Each:
	@ Dimensions Each:				@ Weight Each:
	@ Dimensions Each:				@ Weight Each:
	@ Dimensions Each:				@ Weight Each:
	@ Dimensions Each:				@ Weight Each:
	@ Dimensions Each:				@ Weight Each:

Total Weight:

Section 3 Event Information

Event Name: _____
Event Location: _____
Consignee / Exhibitor Name: _____ Booth #: _____
Address: _____

- Upon receipt of this completed form, Mendelssohn Event Logistics Transportation Services will issue a quotation based on the information provided.
- In order to book your pick-up, the quotation must be signed and faxed back to (514)987-3446.
- All quotations provided by Mendelssohn Event Logistics Transportation Services are for Transportation ONLY and DO NOT include Customs Brokerage Charges.
- To receive a quotation for Customs Brokerage Charges and/or Cargo Insurance, a Canada Customs Invoice/Commercial Invoice must be provided.

Shipment Order Form

Customs and
Transportation Services

Tel: (514)987-2700
Toll Free: (800)665-4628
Fax: (514)849-3446

MENDELSSOHN EVENT LOGISTICS

To obtain a quotation for Mendelssohn Event Logistics Transportation Services, please complete this form and fax to (514)849-3446.

Section 1 Pick-Up Information

Shipper: ABC Distributing Company

Address: 125 Elm Street

City: Chicago

State: IL

Zip: 66666

Contact: Joe Smith

Tel: 708-555-1212

Fax: 708-555-2222

Hours of Operation: 9:00 am - 5:00 pm

Dock: Yes No

Lift Gate Required: Yes No

Inside Pick-Up: Yes No

Pick-Up Date: April 3/07

To Arrive By: April 9/07

Section 2 Freight Information

COMMODITY: Exhibit Related Articles

# of Pieces	Box/Crate/etc.		Length	Width	Height		Per Piece
7	Crates	@ Dimensions Each:	22	13	18	@ Weight Each:	27 lbs
4	Cartons	@ Dimensions Each:	12	12	12	@ Weight Each:	28 lbs
		@ Dimensions Each:				@ Weight Each:	
		@ Dimensions Each:				@ Weight Each:	
		@ Dimensions Each:				@ Weight Each:	
		@ Dimensions Each:				@ Weight Each:	
		@ Dimensions Each:				@ Weight Each:	
		@ Dimensions Each:				@ Weight Each:	
		@ Dimensions Each:				@ Weight Each:	
		@ Dimensions Each:				@ Weight Each:	

Total Weight: 301 lbs

Section 3 Event Information

Event Name: International Computing Event

Event Location: Event Facility

Consignee / Exhibitor Name: ABC Distributing Company

Booth #: 234

Address: 100 Anywhere Street

Toronto, ON

M7W 2P6

- Upon receipt of this completed form, Mendelssohn Event Logistics Transportation Services will issue a quotation based on the information provided.
- In order to book your pick-up, the quotation must be signed and faxed back to (514)849-3446.
- All quotations provided by Mendelssohn Event Logistics Transportation Services are for Transportation ONLY and DO NOT include Customs Brokerage Charges.
- To receive a quotation for Customs Brokerage Charges and/or Cargo Insurance, a Canada Customs Invoice/Commercial Invoice must be provided.